



Marais 36
2400, Le Locle
Switzerland
mpi@bluewin.ch

Phone: +41- (0)-32-9314045
email: mpi@mpi-ultrasonics.com
<http://www.mpi-ultrasonics.com>
<http://mastersonics.com>

WELDING generators

Can drive any kind of ultrasonic transducers: for cleaning, welding, sonochemistry, bonding, machining...

Without LCD Display	STANDARD FEATURES INCLUDE:	With LCD Display
 <p>400W</p>	<ul style="list-style-type: none"> . Automatic Frequency Tuning . Digital Amplitude Control . Good Part/Bad Part Output Signal . Multiple Job Storage - 1000 W and up . Weld quality monitoring is available in time, energy and distance . Ultrasonics Load Meter Scale . Upper and Lower Weld Quality Settings . PLC I/O (Input/Output) Ports . Soft Start Overload Protection Circuitry . Load Regulation Circuitry 	 <p>400W</p>
 <p>1000W</p>		 <p>1000W</p>
 <p>2000W</p>		 <p>2000W</p>

Power available in 400W, 1000W and 2000W

Item	Data base system		
	WG-400 W	WG-1000 W	WG-2000 W
Power	max. 400 W	max. 1000 W	max. 2000 W
Frequency	20 kHz- 100kHz		
Amplitude	constant and load-independent amplitude at the transducer possible with: analog voltage, RS 485 interface		
Interfaces	<ul style="list-style-type: none"> . status LED's . PLC-interfaces . Remote support via RS485 		
Protectict against	<ul style="list-style-type: none"> . overload . short circuit . overtemperature 		
Connectors on the rear of the generator	<ul style="list-style-type: none"> . line-connector . RF-connector (HV-BNC) . interface-connector Canon 15 . RS485 		
Mains:	216-240VAC 50÷60Hz		
Currentconsumption	dependant on the modul max 7A		
Dimmensions (mm)	250 x 210 x 80	270 x 250 x 135	435 x 380 x 100
Weight		4.4 kg	
Standards	CE-conformity		
Application	welding, bonding		

ATTENTION: A shielded control cable must always be used for the RS485-USB interface.

We can produce customized Ultrasonic Power Supplies of any higher power on demand, customized for specific loads.

Ultrasonic World Message

- 1. Our** ultrasonic power supplies are compatible or easily modifiable to drive almost any piezoelectric ultrasonic transducer presently used/known in High Power Ultrasonics Industry (of course, modifications in critical and demanding cases should be made in our labs).
- 2. We** have the largest and modifiable frequency-window controls (almost any frequency interval, compared to 1 until 2 kHz from competition).
- 3. We** can replace almost any industrial ultrasonic power supply that is presently available from competitors (of course, not immediately, but still after a very short time after we get necessary information from a client).
- 4. Our** ultrasonic power supplies are using advantages of dynamic load power regulation between series and parallel resonance (capturing even wider frequency intervals). We can operate any piezoelectric, ultrasonic transducer in its resonant, fixed frequency regimes, in any numerically selected operating frequency interval, and in many forced, arbitrary frequency-modulated wideband regimes.
- 5. We** implement (safe operating) internal scanning procedure in order to select the optimal operating regime and settings for certain ultrasonic transducer.
- 6. Our** Ultrasonic Power Supplies have smooth power and amplitude regulation. We are applying limitation of maxima load power, maximal transducer amplitude and maximal output voltage on piezoceramics. We are applying overheating, short-circuit, over-current and over-voltage protections.
- 7. We** can produce customized ultrasonic power supplies without power limitations (operating until 100 kHz or higher).
- 8. Our** standard line of Ultrasonic Power Supplies is operating on European main supply voltage input, being tolerable to input voltages from 200 Vac until 240 Vac, 50/60 Hz. We can easily produce the same Power supplies for other input voltages (115 Vac 50/60 Hz). Internally, all of our standard Ultrasonic Power Supplies have stabilized, universal voltage SMPS for control and logic modules operating from 95 to 265 Vac. We can also (optionally) apply high power PFC input for customized Power Supplies.

9. We have the largest number of settings regarding operating parameters and conditions controls, frequency modulations, forced and/or automatic resonance-regimes driving, applicable for all presently known Industrial Ultrasonics Applications (such as welding, cleaning, sonochemistry, materials processing, ultrasonically assisted metallurgy, bonding, sieving, cutting, machining, atomizing, driving multi-frequency & wideband transducers etc.). Nevertheless, it is good to know that the biggest challenge in operating different ultrasonic loads (and transducers) is related to the fact that all electrical adjustments and settings are completely related to properties of mechanical system we would like to drive. The same transducer (with different mechanical loading) can produce different output power at the same output voltage and frequency. In certain cases, it is necessary that the first-time modifications and settings be made in our labs. Systematically we are converging to design solutions for ultrasonic power supplies, which are close to universal, but there will always be a space when client will need our assistance. Until present, nobody is offering such options. In addition, we have internally adjustable compensating, inductive and capacitive components, adjustable voltage outputs etc.

10. Our Ultrasonic Power Supplies have all kind of modern industrial control options (PLC, PC software controls, LabView, ModBus, USB, analog input controls...). We can customize and introduce any other control option. Our ultrasonic generators can be controlled with:

- any kind of PLC
- analogue control signals from 0-10V
- amplitude variable and discrete signals
- on/off switching, error signals, etc
- or with RS485 based communications (we are giving the communication protocol).

11. Once after optimal settings are made (on certain of our ultrasonic power supplies, and for certain converter), there is almost no need to do anything more. Just use it on a usual way as using any other modern ultrasonic generator, and control only basic parameters (like timing, amplitude, energy etc.). There is no more need to use LabView software controls.

Literature: [Piezoelectric Transducers Modeling and Characterization \(e-book\)](#)

Load current and load voltage, Start-up, rising times until getting regulated and stable amplitudes

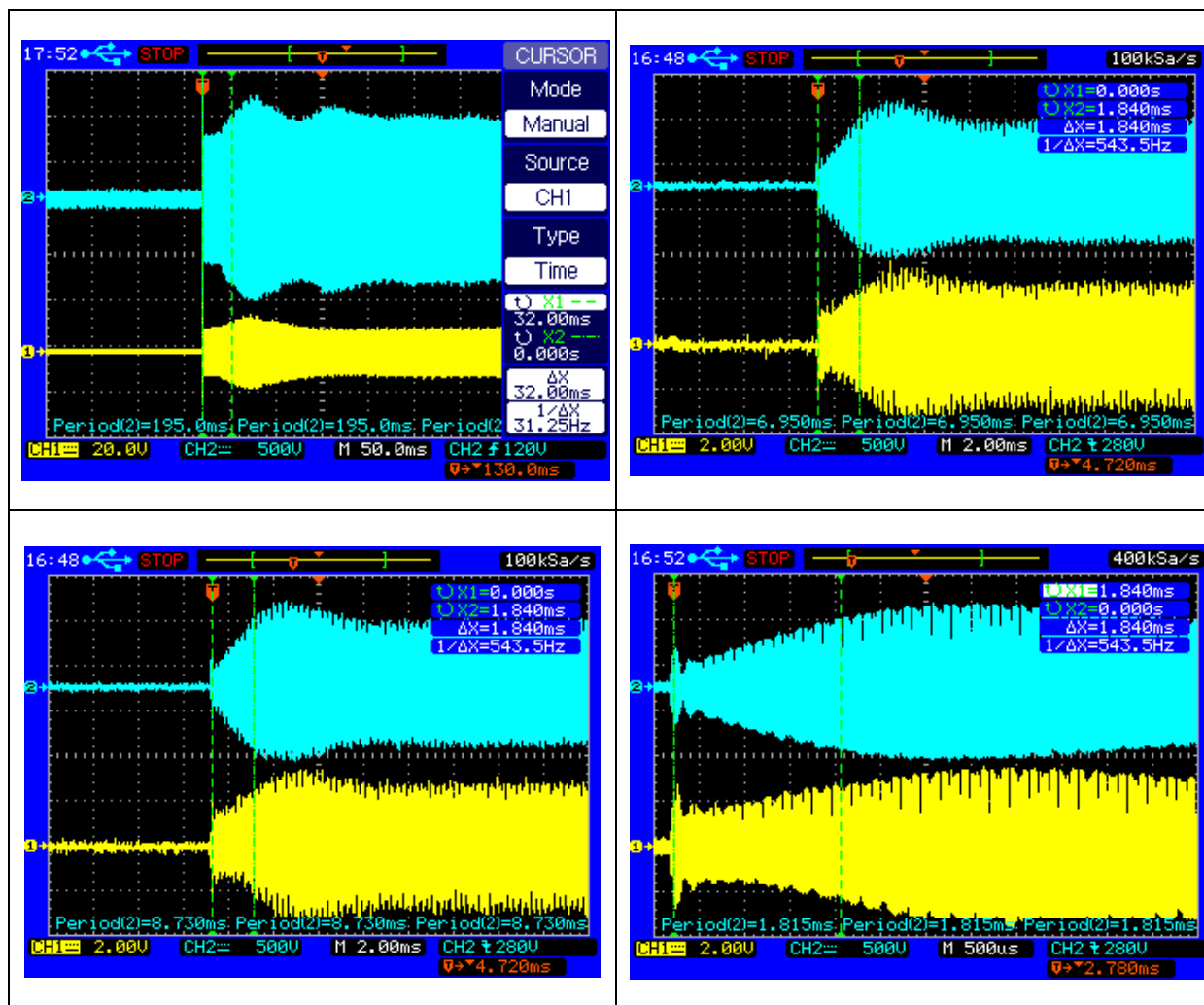

Measured transient time intervals (presented here) are in the range of 2 ms, enabling very fast welding and pulse repetitive regimes. Compare it with competition and you will see that we are for an order of magnitude faster.

INTRODUCTION

Please read these operating instructions carefully and follow them before installing or commissioning your product. Failure to observe these instructions can present a risk to life.

Units may be operated by trained personnel only.

Failure to comply with this will result in a loss of warranty rights.

The device may only be operated and maintained by personnel who have read and understood this operating manual and are familiar with the applicable legal regulations for accident prevention and workplace safety.

ASSEMBLY

In addition, ambient temperatures of over 30°C should be avoided.

Choose a suitable location that will protect the device from moisture, water, excessive sunlight and heat.

- ATTENTION:**
- Choose a location that will prevent steam or any other aggressive vapors from penetrating the device.
 - Over a period of time, chemically contaminated ambient air can lead to the device being irreparably damaged.

Power supply

The ultrasonic generator draws its power (230 V / 50 / 60 Hz) via the connection cable.



It has an internal main fuse (10 AF).

If you need to change the fuses, unscrew the top of the housing.

ATTENTION:

- For safety reasons, always disconnect the unit from the mains before changing fuses.
- Plug racks into earthed sockets only.
- Always replace blown fuses with new fuses of the same type.
- This should only be performed by qualified, skilled personnel.

Connections on the back of the generator**HF OUTPUT:**

Output of the HF voltage (possible to have different high voltage connectors).

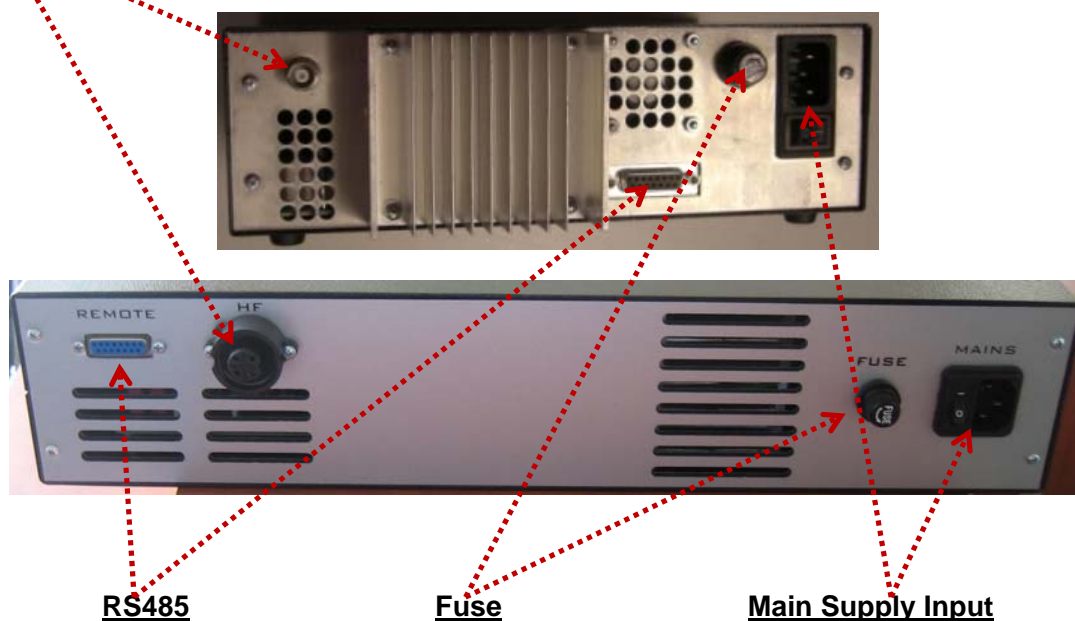
**RS485****Fuse****Main Supply Input****ATTENTION:**

- Use only cables specified by the manufacturer.
- Use only shielded transducer connection cables.
- Connect the shielding to the PE conductor on the generator side.
- Only use cables with sufficient cross-section.
- Minimum wires cross-section: 1.5 mm².

Assignment of the 15-pole DSUB interface socket (RS485)



PIN No. on DSUB SOCKET Interface X1	Signal name	Description
1	+12 VOLT OUT	12 Volt for external use
2	POUT	Output 0 – 10 Volt = Power output 0 – 100 %
3	P-EXT.-IN	Input 0 – 10 Volt for power control
4	GND	Shared reference point = Ground
5/9	HF-DA-ERROR	Relay root (shared) for "HF-DA" and "ERROR"
6	HF-DA	Relay output "HF-DA"
7	ERROR	Relay output "ERROR"
8	A	A signal of RS 485 interface
9/5	HF-DA-ERROR	Relay root (shared) for "HF-DA" and "ERROR"
10	B	B signal of RS 485 interface
11	<> Nominal	Output for nominal value
12	FAN-ON	Monitoring output = 12 Volt when the fan is running
13	FS-24 V	Remote control input (with 12 – 24 Volt)
14	FS-GND	Remote control input (to GND)
15	GND	Shared reference point = Ground

ATTENTION: A shielded control cable must always be used for the RS485 interface.

-RS485 industrial interface is available on pin 8, 10.

(We can give our Interface protocol to interested clients).

-Otherwise generator could be controlled with on/off 12 to 24 volts signal on pins 13, 14.

-Output power could be controlled by 0-10V on pins 3, 4.

-All these features make our WELDING generator very flexible for controls by PLC, HMI or SCADA systems.

-Our new digital WELDING generator could be set at any operating frequency in the range 15 to 100 kHz with accuracy of 0.03 Hz* (of course ultrasonic transducer and load should be able to operate in a desirable frequency range...).

Interface Description (RS485)

1) Signal “+12 Volt Out”

DSUB PIN 1

A voltage of 12 V is available at this output. This voltage can be loaded with max. 100 mA and can, for example, be used to output a voltage for the function “HF-DA” and/or “Error”.

This voltage can also be used to switch on the generator on the input “FS-24 V”.

2) Signal “POUT”

DSUB PIN 2

At this output a voltage proportional to the power output of between 0 and 10 V

(= 0 % – 100 % power output) is available.

Reference point = “GND”.

3) Signal “P-EXT.-IN”

DSUB PIN 3

By connecting a voltage between 0 V and 10 V, the output of the generator can be set to between 0% and 100 % of its nominal amplitude or power.

Reference point = “GND”.

4) Signal “HF-DA ERROR”

DSUB PIN 5/9

Shared in/output for the internal relays “HF-DA” and “ERROR” (these PINs are connected internally).

5) Signal “HF-DA”

DSUB PIN 6

If the ultrasonic generator has been switched on via of the signals “FS-24 V”, “FS-GND” and is producing HF voltage (i.e. there is no malfunction), an internal floating relay contact is closed. (between PIN 6 und PIN 5/9)

The “root” of this relay contact leads through to a PIN 5/9 (these pins are connected internally) in the DSUB socket.

A voltage connected to Pin 5/9 can be switched through (max. 24 VDC / 100 mA).

Standard factory setting: Contact closed when the generator outputs HF voltage.

6) Signal “Error”

DSUB PIN 7

This is the output of an internal relay (root to PIN 5/9).

This relay reports generator malfunctions. This means that if the generator is switched on and, for some reason, the power output does not correspond to the set level, this relay is activated.

Factory default settings: Closed in the event of a malfunction. It is possible to change the polarity in the Settings menu under the heading I/O Polarities (“Error detect”).

An external voltage connected to “HF-DA-Error” can, of course, also be switched through here (max. 24 VDC / 100 mA).

7) Signal “FAN-ON” **DSUB PIN 12**

At this output, there is a control voltage (12 Volt) for monitoring the fan function when the internal fan is running.

8) Signal “FS-24 Volt” **DSUB PIN 13**

Switching on the generator (Ultrasound On) by connecting a voltage between 15 – 24 Volt between PIN 13 and GND (PIN 4/15).

9) Signal “FS-GND” **DSUB PIN 14**

Switching on the generator (ultrasound ON) with a relay contact or switch by connecting PIN 14 on the DSUB socket to GND (PIN 4 /15).

10) Signal “<> Nominal” **DSUB PIN 11**

Open Collector output: high signal if a window function is active and the generator is operated outside the window set; low signal if a window function is active and the generator is operated within the window set.

11) Signal “GND” **DSUB PIN 4, 15**

The GND signal is available on multiple pins of the DSUB socket.

It is the common reference point for all input and output signals.

12) Relay WARNING **DSUB PIN 16**

This is the output of an internal relay (root to PIN 5/9).

This relay reports generator malfunctions. This means that if the generator is switched on and, for some reason, the power output does not correspond to the set level, this relay is activated.

Factory default settings: Closed in the event of a malfunction:

-Overload

-Occurred Some of Welding limits

An external voltage connected to “HF-DA-Error” can, also be switched through here (max. 24 VDC / 100 mA).

13) DSUB PIN 22,23,24,25

Selecting internal programs with different settings.

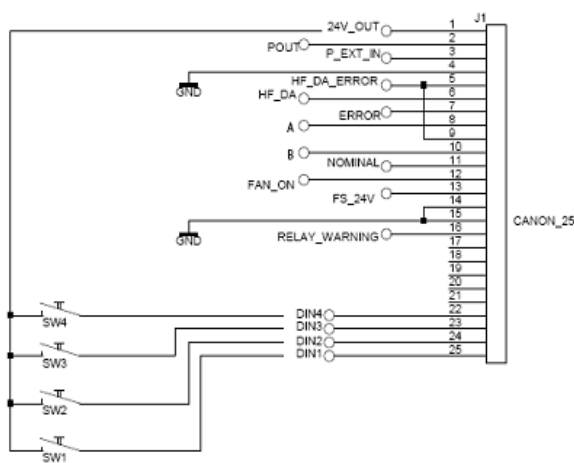

	SW1	SW2	SW3	SW4	
	OFF	OFF	OFF	OFF	TRANSDUCER 0
	ON	OFF	OFF	OFF	TRANSDUCER 1
	OFF	ON	OFF	OFF	TRANSDUCER 2
	ON	ON	OFF	OFF	TRANSDUCER 3
	OFF	OFF	ON	OFF	TRANSDUCER 4
	ON	OFF	ON	OFF	TRANSDUCER 5
	OFF	ON	ON	OFF	TRANSDUCER 6
	ON	ON	ON	OFF	TRANSDUCER 7
	OFF	OFF	OFF	ON	TRANSDUCER 8
	ON	OFF	OFF	ON	TRANSDUCER 9



Protocol for serial port communications for Welding generators

Data format 115200 baud 8 bit no parity 2 stop bits

RS485 100 ohm standard line

Request for parameter

%06f<cr> request for frequency

%06d<cr> request for amplitude

%06s<cr> request for span

%06p<cr> request for phase

%06t<cr> request for time

%06k<cr> request for peak power

%06e<cr> request for energy

%06r<cr> request for time limit plus

%06o<cr> request for time limit minus

%06l<cr> request for peak power plus

%06u<cr> request for peak power minus

%06v<cr> request for energy limit plus

%06w<cr> request for energy limit minus

%06c<cr> request for output capacitor

%06?<cr> request for parameters

Answers

#02fxxxxx<cr> answer for frequency scale 1Hz

#02dxxxxx<cr> answer for amplitude scale 0.1%

#02sxxxxx<cr> answer for span scale 1Hz

#02pxxxxx<cr> answer for phase scale 5mV

#02txxxxx<cr> answer for time scale 0.01s

#02kxxxxx<cr> answer for peak power scale 1W

#02exxxxx<cr> answer for energy scale 1Ws

#02rxxxxx<cr> answer for time limit plus scale 0.01s

#02oxxxxx<cr> answer for time limit minus scale 0.01s

#02lxxxxx<cr> answer for peak power limit plus scale 1W

#02uxxxxx<cr> answer for peak power limit minus scale 1W

#02vxxxxx<cr> answer for energy limit plus scale 1Ws

#02wxxxxx<cr> answer for energy limit minus scale 1Ws

#02cxxxxx<cr> answer for output capacitor scale 1nF

#02?aaappppffffsvvvaaaeetttrrrr<cr> answer for parameters

-aaa - amplitude scale 0.1%

-ppp - phase scale 5mV

-ffff - frequency scale 1Hz

-s status

0 - off

1 - on

2 - overheat

3 - overcurrent

- 5 - limit time
- 6 - limit peak power
- 7 - limit energy
- 8 - untested
- 9 - overload

-vvv actuator value of internal regulator scale 0.1%
 -aaa power scale 1W
 -eeee last weld energy scale 1Ws
 -tttt last weld time scale 0.01s
 -rrrr peak power scale 1W

Settings

#06fxxxxx<cr> set frequency scale 1Hz
 #06dxxxxx<cr> set amplitude scale 0.1%
 #06sxxxxx<cr> set span scale 1Hz
 #06pxxxxx<cr> set phase scale 5mV
 #06txxxxx<cr> set time scale 0.01s
 #06kxxxxx<cr> set peak power scale 1W
 #06exxxxx<cr> set energy scale 1Ws
 #06rxxxxx<cr> set time limit plus scale 0.01s
 #06oxxxxx<cr> set time limit minus scale 0.01s
 #06lxxxxx<cr> set peak power limit plus scale 1W
 #06uxxxxx<cr> set peak power limit minus scale 1W
 #06vxxxxx<cr> set energy limit plus scale 1Ws
 #06wxxxxx<cr> set energy limit minus scale 1Ws
 #06cxxxxx<cr> set output capacitor scale 1nF

Answer for settings

><cr>

Remark - <cr> is ASCII code for 'Carriage return' hex code 0x0D decimal 13

Start generator

@06start<cr>

Answer for start

ok<cr>

Stop generator

@06stop<cr>

Answer for stop

ok<cr>

Write to eeprom memory

@06wr<cr>

Answer for write

ok<cr>

GENERATOR CONTROLS

Operator elements and display on the front panel



LED-on: Lights up when the device is being supplied with mains voltage correctly and the power switch is ON

LED-error: Lights up in the event of an error



ON/OFF button: The generator is switching on and off by pressing this button.



Menu - Encoder / Select: For setting and entering values

The LCD

Amplitude



Display shows the set value of output power and its performance on "A" bar. From 0% to 100% of nominal generator power. During initial testing of new sonotrodes, set the amplitude to some low value (example: 5% to 10%).









Start Frequency

Here encoder can be used to set the initial operating frequency (which is little bit higher than f_p). Here, the encoder can be used to adjust the starting frequency. **Start frequency f -start can be changed/adjusted also during the generator operation.** The generator has an automatic "frequency tuning" inside the **frequency capture range** (see the explanation which follows). The frequency capture range can be set by "Span" parameter from 0 to 1 kHz (below the start frequency, towards lower frequencies: f -capture = f -start - Span). The operating resonant frequency of ultrasonic system must be found in advance (before operating the system full-power), performing initial low power scan-testing with the generator Lab View software. This frequency will be found somewhere below the frequency where scanned generator current is maximal, and where the scanned phase function is smoothly rising from its minimal value towards its maximum, when in the same time, the frequency is going towards lower frequencies). The frequency area which is covered (by this type of regulation) depends on the device type (it is impedance-characteristic dependent: f -capture = f -start - Span).



<p>Welding process will stop after given <u>Time</u> interval (here 3.83 s). There are <u>no limits for operating Power and delivered Energy</u> (because of zero settings).</p>	
<p>“<u>Welding by limiting the Peak power on the load</u>”. Welding process will stop when <u>Peak power</u> is reached. There are <u>no limits for total operating Time and delivered Energy</u> (because of zero settings).</p>	
<p>“<u>Welding by limited amount of Energy</u>” which should be sent to a load. Welding process will stop when <u>given amount of Energy</u> is delivered to a load (here 1208 Ws). There are <u>no limits for total operating Time and operating Peak power</u> (because of zero settings).</p>	

<p>Time plus (=) maximal allowed operating time which can drive a load (here 7.52 s). If real operating time would be for some reason higher than Time plus, generator will produce error message on the front panel of generator box and on the software user interface.</p>	 <p>The image shows the front panel of a generator control unit. A green LCD screen displays 'Time+ 0,00s OK' with a downward arrow. Below the screen is a rotary knob labeled 'MENU' and a push button labeled 'ON/OFF'. The screen also shows 'TA' with a horizontal bar and 'OLast 1,51 s'.</p>
<p>Time minus (=) minimal allowed operating time which can drive a load (here 2.08 s). If real, actual load operating time would be for some reason lower than Time minus, generator will produce error message on the front panel of generator box and on the software user interface.</p>	 <p>The image shows the front panel of a generator control unit. A green LCD screen displays 'Time- 0,00s OK' with a downward arrow. Below the screen is a rotary knob labeled 'MENU' and a push button labeled 'ON/OFF'. The screen also shows 'TA' with a horizontal bar and 'OLast 1,51 s'.</p>
<p>Peak power plus (=) maximal allowed Peak power which can drive a load (here 193 W). If real, actual load Peak power would be for some reason higher than Peak power plus, generator will produce error message on the front panel of generator box and on the software user interface.</p>	 <p>The image shows the front panel of a generator control unit. A green LCD screen displays 'Peak+ 0W OK' with a downward arrow. Below the screen is a rotary knob labeled 'MENU' and a push button labeled 'ON/OFF'. The screen also shows 'TA' with a horizontal bar and 'OLast 702 W'.</p>

<p>Peak power minus (=) minimal allowed Peak power which can drive a load (here 85 W). If real, actual load Peak power would be for some reason lower than Peak power minus, generator will produce error message on the front panel of generator box and on the software user interface.</p>	 <p>The image shows a close-up of the generator's control panel. The green LCD display shows 'Peak-' followed by '0W OK' and a downward arrow. Below this, it shows 'TA' with a horizontal bar and '0Last 702 W'. Below the display is a rotary knob labeled 'MENU' and a push button labeled 'ON/OFF'.</p>
<p>Energy plus (=) maximal allowed Energy which can drive a load (here 1651 Ws). If real load Energy would be for some reason higher than Energy plus, generator will produce error message on the front panel of generator box and on the software user interface.</p>	 <p>The image shows a close-up of the generator's control panel. The green LCD display shows 'En+' followed by '0Ws OK' and a downward arrow. Below this, it shows 'TA' with a horizontal bar and '0Last 1001 Ws'. Below the display is a rotary knob labeled 'MENU' and a push button labeled 'ON/OFF'.</p>
<p>Energy minus (=) minimal allowed Energy which can drive a load (here 866 Ws). If real load Energy would be for some reason lower than Energy minus, generator will produce error message on the front panel of generator box and on the software user interface.</p>	 <p>The image shows a close-up of the generator's control panel. The green LCD display shows 'En-' followed by '0Ws OK' and a downward arrow. Below this, it shows 'TA' with a horizontal bar and '0Last 1001 Ws'. Below the display is a rotary knob labeled 'MENU' and a push button labeled 'ON/OFF'.</p>

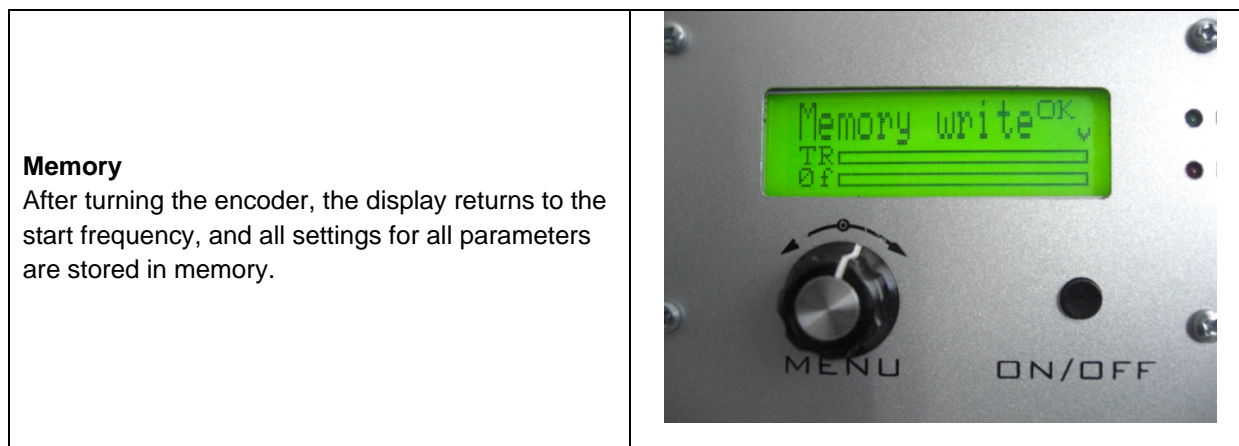

When a PC (through communication cable and RS485 interface) is connected to the generator, PC automatically starts regulating the generator with higher priority. When a PC is disconnected, it is immediately possible to use regulations on the front panel of the generator.

After all initial settings are made (using a PC and supplied Lab View software), Ultrasonic Generator can be activated, and it will start driving ultrasonic converter by pressing **ON/OFF** button (which is on the front panel). Do not start the generator until all initial settings are verified and set to safe (low power and low risk) positions.

Frequency-capture range = Span:

This is the safe-operating, low-power frequency scanning of ultrasonic load (Ultrasonic converter + booster + sonotrode + etc.), where the scanning display would visualize the phase difference versus frequency between a load current and load voltage (red color curve), and input DC generator current (white color curve). Such frequency scanning is realized using the Lab View software supplied with ultrasonic generator). In order to make scanning, personal computer with installed Lab View software should be connected to ultrasonic generator through RS485 interface.

Initially (first safe-operating, low power frequency scanning) should be selected to cover only the expected operating frequency range of ultrasonic system.

In here-described scanning, frequency is smoothly changing towards lower values, starting from f-start and finalizing scanning at the frequency which is equal to f-start – Span. Span is the frequency interval we select as a frequency-capture range (in Lab View Software).

For instance, if ultrasonic system consists of: 20 kHz ultrasonic converter + 20 kHz booster + 20 kHz sonotrode (where not all of them are exactly tuned to operate on 20 kHz, or to have single operating frequency of 20 kHz), we know that we should expect the resulting, central operating frequency of such system to be somewhere close to 20 kHz, and consequently, we could select the scanning frequency range to be between 20 and 21 kHz (meaning f-start = 21 kHz, and Span = 1 kHz). Of course, another relevant example could be to select such frequency scanning between 19.5 kHz and 20.5 kHz (meaning: f-start = 20.5 kHz, Span = 1 kHz). Later (during scanning), the Lab View software will search and find real, average operating frequency somewhere inside of the area covered by scanning).

When/where generator input DC current (during such scanning) is reaching certain relative maximum (at certain frequency), this is indicating that ultrasonic load is also consuming certain power, and/or increasing its oscillating activity. This is the reason why we are taking such DC current maximum as the (upper) reference point for frequency scanning. In reality, this is also related to impedance curve of ultrasonic system under testing, since empirically we know that central operating frequency of a stable operating regime of ultrasonic system (in WELDING regime, under wideband frequency sweeping) should be below the frequency when the input DC current is reaching its maximum. This is also the reason to select an initial f-start just below the frequency where DC current is reaching maximum, and where the phase-difference function has its minimum (with a tendency to grow towards lower frequencies).





In the next step (next safe-operating frequency scanning) we should select new (shorter) value for Span to cover only the closest part of the phase-curve (red color), which is showing the part of phase-difference curve starting from certain minimal value until its first maximal value (below the frequency where input, DC generator current is maximal). New f-start will be again at the point where the phase curve is minimal.

This way, we will visualize mentioned part of the phase difference curve on a larger display, and we will be able to estimate the frequency which is in the middle of that frequency interval, and which is approximately equal: $f\text{-start} - 0.5(\text{Span})$. Later, real WELDING operating frequency regime (under automatic regulation found by internally implemented hardware and software) will find its average or central operating frequency (inside of the new **Span** interval) and we will be able to perform/set large frequency sweeping around that frequency (in both directions). One of examples showing such experimental frequency Span determination of the most promising WELDING operating zone will be presented later.

MPI WELDING Generators Software

Please follow initial steps:

1. Go here and download necessary software files (MS Windows XP,32 bits):
http://www.mastersonics.com/documents/mmm_basics/mmm_power_supplies/WELDING/
Comment: Create WELDING (directory) box on a PC desktop that will be used to control your WELDING generator. Place inside of the WELDING box the following files:

 MPIwelding	exe
 MPIwelding	aliases
 MPIwelding	ini
 CDM 2.04.06	exe

2. Install, if not already installed, USB driver (CDM 2.04.06.exe). Click-on [CDM2.04.06.exe](#) () and this will install RS485 driver.

If necessary, install the latest driver for USB to RS485 adapter (take the driver here: <http://www.ftdichip.com/FTDrivers.htm>). Connect ultrasonic generator to a PC using the RS485-USB adapter (supplied with the WELDING generator; -see the picture below). Switch ON the main switch of your WELDING ultrasonic generator (This is only a main supply power input; -for instance 230 Vac, 50/60 Hz. Ultrasonic output power is still not activated). PC will not connect to ultrasonic generator if generator is not powered by main supply input.



3. Activate **RS485-USB** connection line between your WELDING generator and your PC (select proper, active serial, COM port, Open Serial port dialog, rescan/refresh if necessary... until LEDs on the **RS485-USB** box will start blinking):

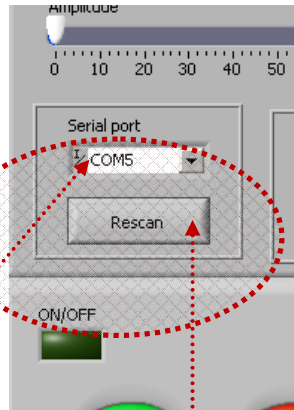

In the lower left corner of the software interface (**First TAB**) it is necessary to select a free/available **COM port** and/or press **Refresh/Rescan** (this will activate the connection between the generator and a PC; -see pictures below). If necessary make Refresh again (or restart generator, exit/close and activate again **MPIwelding.exe**, unplug and plug cables... until RS485-USB connecting line is activated). Lab View software will properly select relevant port for realizing RS485 communications (or if this is not the case, see which serial port is open and available, and activate it manually in the upper left corner of user-interface software).

For double checking (regarding COM port selection) go to Control Panel (MS Windows XP) to verify which COM port is assigned to USB-RS485 adapter (see the picture below).

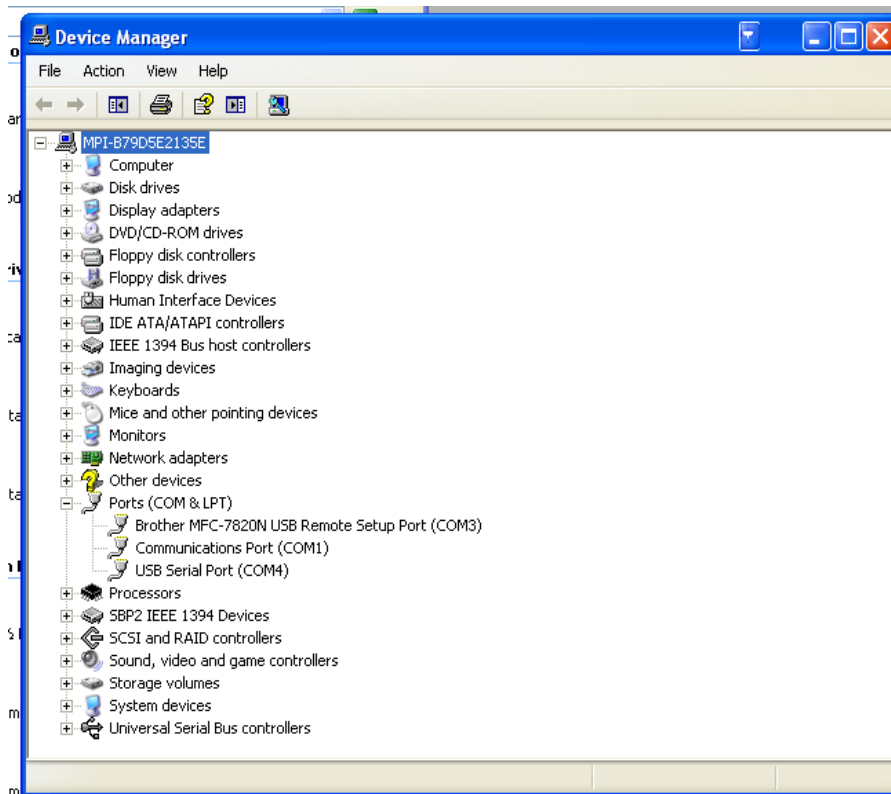

Ultrasonic generator is still not delivering output ultrasonic signal.

4. Install “NI_Runtime8_5”, LabVIEW runtime to a PC/laptop (Windows XP, 32-bits), which will be used to control your WELDING ultrasonic generator (see for software here: <http://joule.ni.com/nidu/cds/view/p/id/861/lang/en>). Verify that the VISA serial port driver for Labview is installed properly (it should be automatically installed with NI runtime software). To be sure that you will have the best installation for serial ports communication, install (in addition) NI-Serial 1.7-Windows/2000/XP. Take the software from here: <http://joule.ni.com/nidu/cds/view/p/id/533/lang/en>
5. Find MS-Windows software “**MPIwelding.exe**” on a PC and start it (take the MPI-Welding LabView software from here: http://www.mastersonics.com/documents/mmm_basics/mmm_power_supplies/AMMM/welding-gen-software/).

When a PC (through communication cable and RS485 interface) is connected to the generator, PC automatically starts regulating the generator with higher priority. When a PC is disconnected, it is immediately possible to use regulations on the front panel of the generator (LCD + rotary encoder + small ON-OFF = start-stop button). Of course, WELDING generators can also be externally controlled using a PLC, or analog controls.

For safety reasons, when ultrasonic system is started first time, when (any or all of): ultrasonic load (transducer, booster, sonotrode ...) are unknown, or new, or replaced, set the **Amplitude** value to certain low value (for instance on 10%). Then start low power testing and scanning in order to find the best operating frequency interval.

-After activating “**MPIwelding.exe**” software ( **MPIwelding**) you will see the following LabVIEW user interface for controlling WELDING generators (which has 3 software settings TABS):



How to change numerical and other setting values for operating frequency and scanning ranges

If we cannot select automatically (by default) proper frequency **Range**, proper **Start frequency**, proper **Span** value and proper scanning range, there is a simple way to do it manually and numerically by direct writing of new, desired values into proper windows.

For instance, if operating frequency **Range** should be something else, compared to what we see on the **Range** window, we can simply click (with a mouse) over the area where frequency interval numbers should appear and type/write on the same way (same format) new frequency interval, like on the picture below:

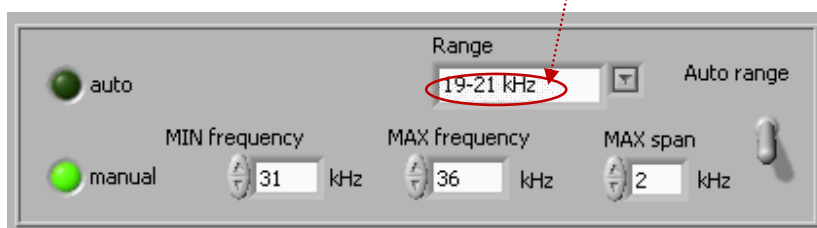

If we would like to change **Start frequency** and **Span** (because by default we do not see desired numbers there), we will again simply click over the last existing numerical position and type new numbers there, like on the pictures below. Old number/s can be simply (manually, by typing) be replaced by new numbers.

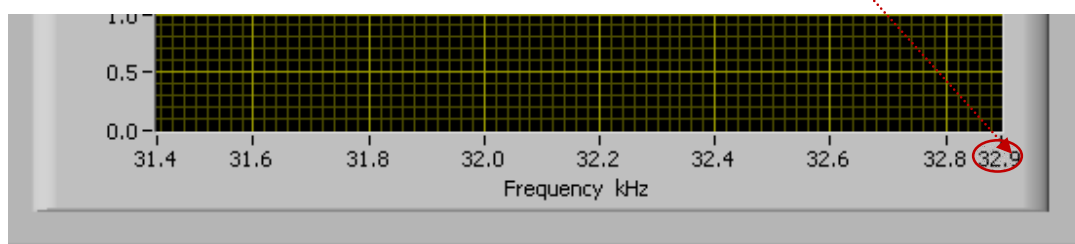
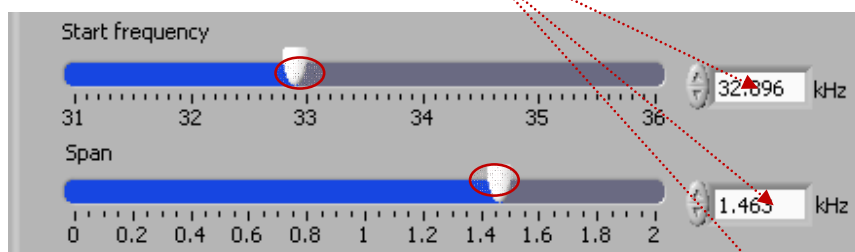

This way we will be able to modify settings and scanning values in order to get most appropriate intervals for specific ultrasonic loads. Of course, certain logic should be respected, since we should not select new numerical values to be outside of the operating limits of WELDING generators.

OPERATING MODES OF WELDING ULTRASONIC GENERATORS

- A) WELDING generators can operate in the **CONTINUOUS TEST MODE** (for scanning, testing and first time settings).

- B) WELDING by given **Time**: Welding by limiting only a welding time. Welding process will stop after given Time interval. There are no limits for operating Power and delivered Energy.

- C) WELDING by **Peak power**: Welding by limiting the Peak power on the load. Welding process will stop when Peak power is reached. There are no limits for total operating Time and delivered Energy.

- D) WELDING by **Energy**: Welding by limited amount of Energy which should be sent to a load. Welding process will stop when given amount of Energy is delivered to a load. There are no limits for total operating Time and operating Peak power.

PARAMETERS & BASIC SETTINGS

Principal software user-interface for controlling WELDING generators: First TAB

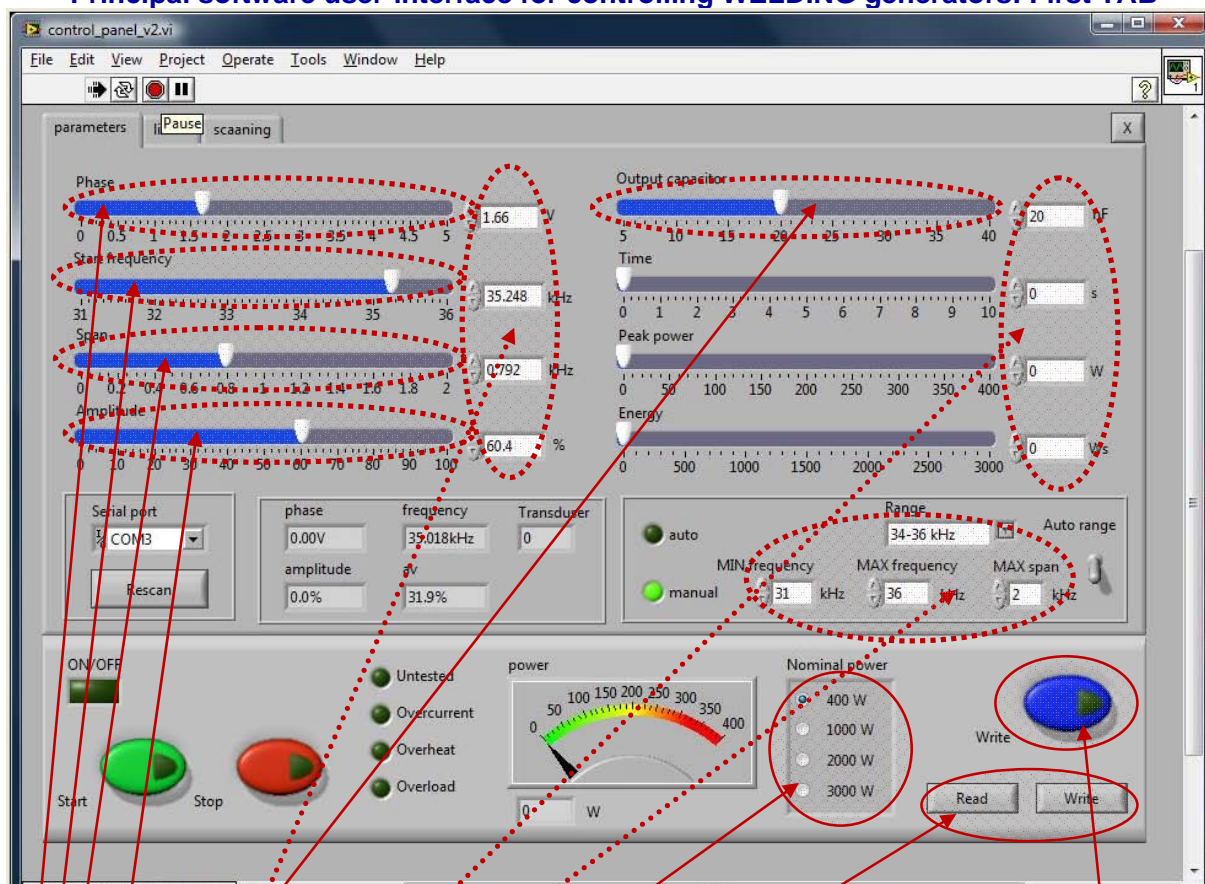

Phase difference settings (after scanning): optimal 2.5 v; -acceptable from 1 V until 3.5 V

Start frequency selection: Usually just above parallel resonant frequency of the transducer

Span (=) operating frequency interval selection (=) Localized inside (Start frequency – Span)

Amplitude (=) oscillating mechanical amplitude selection

Output capacitor (=) Parallel capacitance added to the transducer capacitance (should be selected)

Numerical; manually editable fields (for arbitrary selections of operating intervals which are inside of operating domains of WELDING generators.

Power selector: Should be selected in relation to applied standard generator.

Read – Write options: After all settings are properly and optimally made, we can save the file with such settings using **Write** button (like saving any PC file). Later, we can simply invite/**Read** one of such files (for a specific load) and WELDING generator will start operating as previously memorized. **Blue Write button** is for internal memory saving inside of the generator (should be applied after scanning and any change of settings).

Output capacitor selection

Software selectable **Output capacitor** = $C_{\text{compensating}}$ is related to the output ultrasonic load circuit, and it is optimizing transducer impedance matching with the ultrasonic generator. When capacitance is selected properly, ultrasonic load will produce maximal output power on certain resonant frequency of connected ultrasonic transducer (see the picture below). Select also proper frequency **Range** which corresponds to applied ultrasonic transducer.

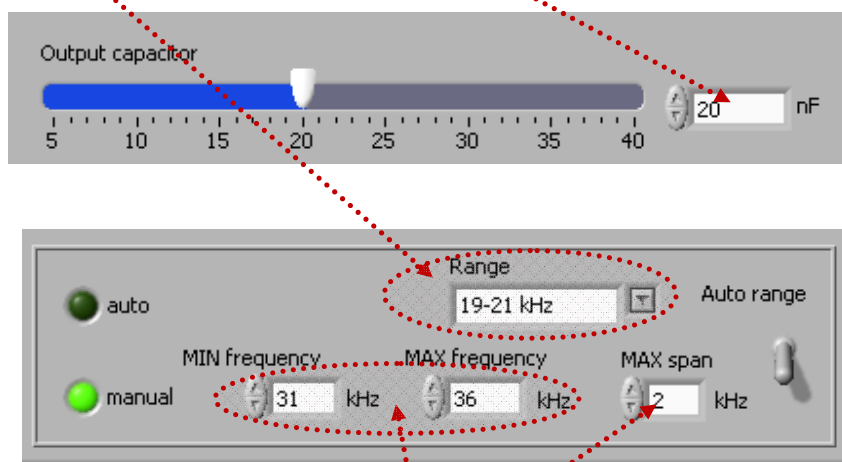

By default, automatically, we have 1 kHz wide **Max. Span, but manually we can select and type another value.**

MAX frequency & MIN frequency corresponds to end-values of the **Start frequency** slider (for instance, here 32 and 38 kHz).

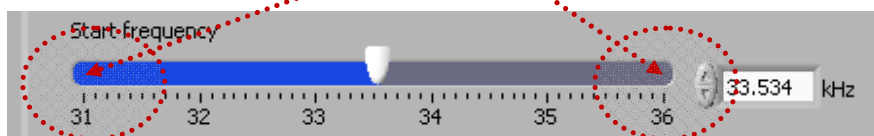

For simplified logical understanding (of such resonant matching), we can imagine that what we connect to the secondary side of the output ferrite transformer is a simple, serial L-C (inductance + certain capacitance) circuit. Ultrasonic converter is connected in parallel to the capacitance of mentioned serial L-C circuit.

Inside of the generator, series compensating inductance is fixed (and has two values internally selectable by jumpers): usually it is 1 mH for most of high power transducers operating around 20 kHz, and 0.5 mH in cases of higher frequency transducers (operating around 40 kHz and higher).

In order to adjust the load impedance to operate optimally on certain operating frequency $f_{\text{transducer}}$, we will effectively increase capacitance of the transducer by adding different, compensating parallel capacitances $C_{\text{compensating}} = \text{Output capacitor}$, this way creating necessary equivalent capacitance C_{eq} . Internally, Welding generator has 8 values of selectable combinations of $C_{\text{compensating}}$ (in steps of 5 nF, such as: 5, 10, 15, 20, 25, 30, 35, 40 nF). Maximal capacitance of 40 nF can be connected in parallel to certain ultrasonic transducer. Inside of the generator (by default), there is always 5 nF capacitance, installed in parallel connection to an output transducer (which cannot be changed or disconnected by LabVIEW software). Only maximum of 35 nF can be added parallel to a transducer by LabVIEW software. This will create the total added capacitance that will go until max. 40 nF (non counting capacitance of the transducer). When we set by LabVIEW software the value of 40 nF, this will show that 40 nF is added in parallel to ultrasonic transducer (5 nF which are always there, and 35 nF which are added by software).

Mathematical formula for calculating necessary parallel capacitance (which should be added to transducer) is:

$$\left\{ \begin{array}{l} f_{\text{transducer}} = \frac{1}{2\pi\sqrt{LC_{\text{eq}}}} = \frac{1}{2\pi\sqrt{LC_{\text{eq}}}} (=) [\text{Hz}] \\ L = L_{\text{compensating}} = 1\text{mH} = 10^{-3}\text{H (or 0.5mH)} \\ C_{\text{eq}} = C_{\text{transducer}} + C_{\text{compensating}} = \frac{1}{4\pi^2 L f_{\text{transducer}}^2} (=) [\text{F}] \\ C_{\text{compensating}} (=) \text{externally added capacitance} \end{array} \right\} \Rightarrow \left\{ \begin{array}{l} C_{\text{compensating}} = C_{\text{eq}} - C_{\text{transducer}} = \frac{1}{4\pi^2 L f_{\text{transducer}}^2} - C_{\text{transducer}} \\ C_{\text{compensating}} = \frac{1000}{4\pi^2 f_{\text{transducer}}^2} - C_{\text{transducer}} \end{array} \right\}$$

Example:

$$\left\{ \begin{array}{l} f_{\text{transducer}} = 20000\text{Hz} \\ C_{\text{transducer}} = 20\text{nF} = 20 \cdot 10^{-9}\text{F} \\ L = 1\text{mH} = 10^{-3}\text{H} \end{array} \right\} \Rightarrow \left\{ \begin{array}{l} C_{\text{eq}} = 20 \cdot 10^{-9} + C_{\text{parallel}} = \frac{1}{4\pi^2 L f_{\text{transducer}}^2} = 60\text{nF} \\ C_{\text{compensating}} = C_{\text{eq}} - C_{\text{transducer}} = (60 - 20)\text{nF} = 40\text{nF} \end{array} \right\}$$

We can measure C_{eq} (inside of WELDING generator, on its output; -parallel to a connected transducer) and compare it with calculated value for C_{eq} in order to be sure that proper equivalent capacitance is reached (or to be sure that proper parallel capacitance $C_{\text{compensating}}$ is connected to the transducer). Parallel capacitance $C_{\text{compensating}}$ (until 40 nF) is software selectable in AMMM generators (with LabVIEW software [MPIwelding.exe](#)). Parallel capacitance can also be added in some other values, manually, by soldering specific capacitors (inside of the generator; -only for experts). **Every time when we (manually) change $C_{\text{compensating}} = \text{Output capacitor}$ by LabVIEW software, we need to stop the generator, since **Output capacitor** will not be automatically changed in real time when ultrasonic converter is**

powered by ultrasonic frequency, high voltage signal. When we stop the generator, software selected output capacitor command will activate internal relays and apply selected capacitor, and after that we can start the generator (in other words, compensating capacitor can be changed only when ultrasonic transducer is not operating; -generator is not producing high voltage output).

Calculated value of $C_{\text{compensating}}$ presents only an approximated and maximal target value of capacitance that can be added in parallel to ultrasonic transducer (that we know how far we can go). In reality, when we make such capacitive impedance matching, we should start (testing ultrasonic transducer when operating in real loading conditions) from minimal value of $C_{\text{compensating}}$ (which is 5 nF). Then, we should gradually increase it until calculated value, or better to say until the other, lower value (which could be below calculated $C_{\text{compensating}}$), until we get optimal operating conditions on ultrasonic load. Optimal operating conditions are related to: reaching maximal load power on ultrasonic transducer, reaching maximal and safe operating voltage on piezoceramics, while still keeping automatic amplitude control and automatic or regulated frequency tracking.

In order to get sufficiently high and still safe operating conditions on ultrasonic load it is recommendable to start with minimal output voltage value on the secondary side of the output ferrite transformer (by connecting proper jumper which corresponds to minimal output voltage). If maximal ultrasonic loading power is still not high enough, we will increase output voltage on the ferrite transformer (by selecting the next value), and this will automatically increase maximal voltage on ultrasonic transducer. We need to be careful that voltage on piezoceramics has its safe limits, and that we need to operate below maximal acceptable voltage (which is usually until 200 V-rms per every millimeter of piezoceramics thickness).

When performing low power scanning (using our LabView software), in order to find or estimate optimal frequency range of certain transducer, compensating capacitance should be set on minimum (= 5 nF). Later, in high power regime, it should be again adjusted to its optimal value (increased).

WARNING (only for experienced and experts)

In cases of new ultrasonic transducers resonant matching (first time testing and tuning) it is important to be very careful with the output voltage on ultrasonic transducer. 100% amplitude (in the software settings) is equal to maximal safe operating and acceptable voltage over the transducer (measured directly on piezoceramics). The RMS voltage should be measured directly on the transducer during all impedance matching and manipulations with output voltages on the output ferrite transformer. Output ferrite transformer has 3, jumper-selectable voltage outputs in order to be able to adjust maximal safe operating voltage. Special high-voltage/high-frequency, wideband RMS voltmeter should be applied when measuring voltage on the transducer (also oscilloscope with differential, isolated channel inputs for high voltage applications).

If transducer has piezoceramics which are 5 mm thick (each of them), maximal RMS voltage on such transducer can be 1000 V (= 1000 x 1.41 V - peak. If transducer has piezoceramics which are only 1 mm thick (each of them), maximal applied RMS voltage on it should not be higher than 200 V (= 200 x 1.41 V – peak).

Be sure you are working in the “CONTINUOUS MODE” (set Time, Peak power, Energy to 0). First TAB, upper right side (when performing first time tuning and matching of new transducer).

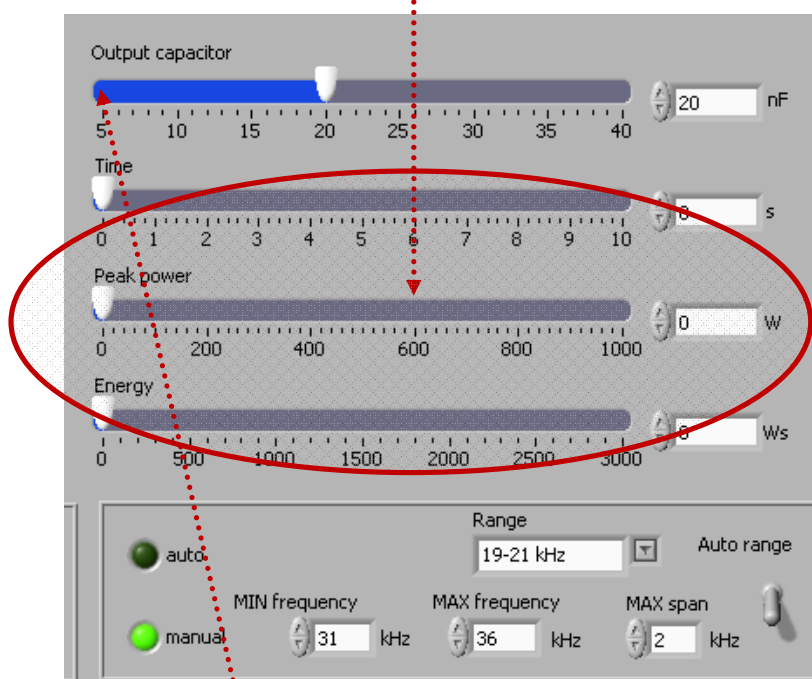

When performing low power scanning (using our LabView software), in order to find or estimate optimal frequency range of certain transducer, compensating capacitance should be set on minimum (= 5 nF).

Examples for calculating compensating capacitance:

C transducer [nF]	C compensation [nF]	L compensa tion [uH]	F[kHz]
3	5	500	100.71
3	10	500	71.21
3	15	500	53.08
3	20	500	50.35
3	25	500	45.04
3	30	500	41.11
3	35	500	38.06
3	40	500	35.61
3	45	500	33.57
3	5	1000	71.21
3	10	1000	50.35
3	15	1000	41.11
3	20	1000	35.61
3	25	1000	31.85
3	30	1000	29.07
3	35	1000	26.92
3	40	1000	25.18
3	45	1000	23.74
20	5	1000	71.21
20	10	1000	50.35
20	15	1000	41.11
20	20	1000	35.61
20	25	1000	31.85
20	30	1000	29.07
20	35	1000	26.92
20	40	1000	25.18
20	45	1000	23.74

Principal software user-interface for controlling WELDING generators:
 First TAB (basic settings): Continuous mode

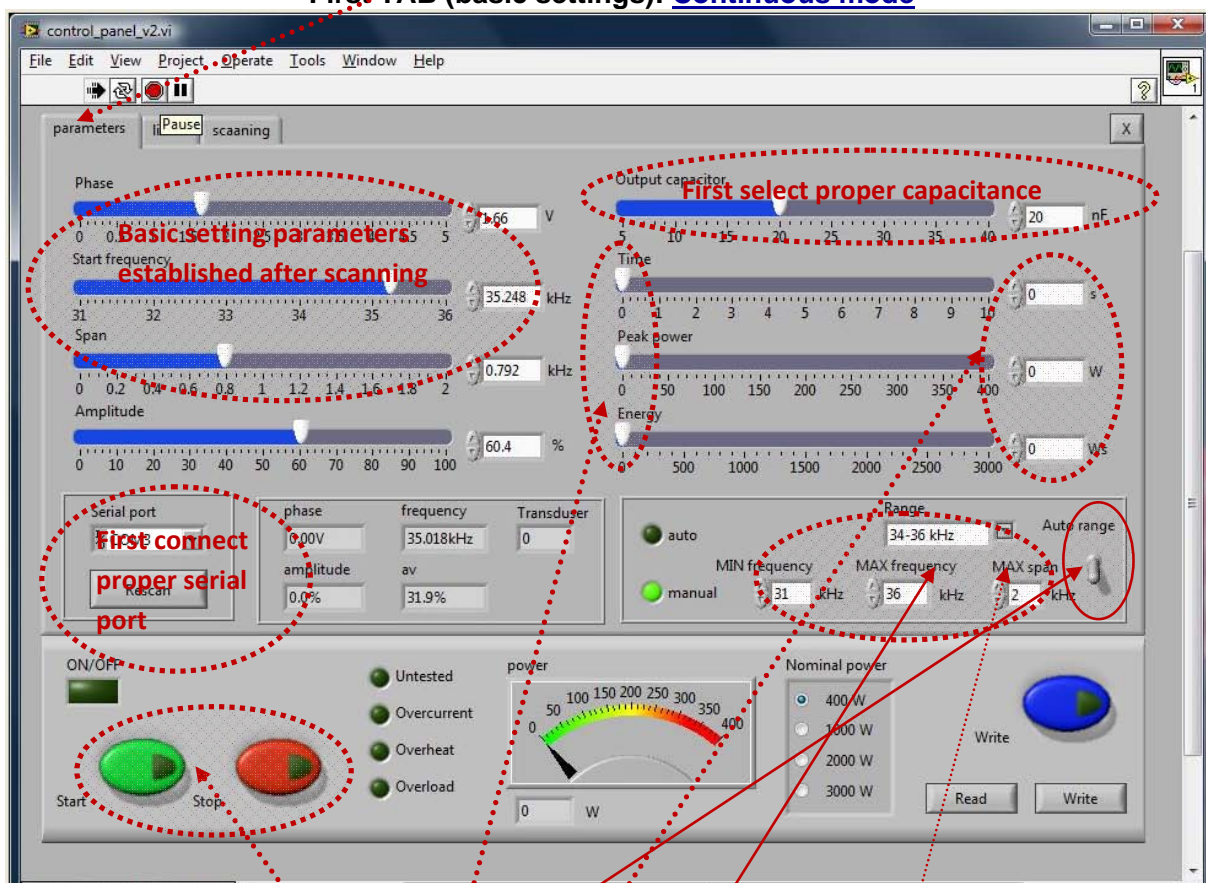

Screen example for continuous operating mode: “TEST operation without limits, for implementing basic tuning and settings for new loads”. Welding process can be controlled by Start and Stop buttons. Output capacitor can be adjusted for optimal impedance-power matching. Every time when parameters of certain operating-mode variable are set to 0 (zero), like here encircled, the LabVIEW software for ultrasonic generators is considering this as: function not in use, or function without limits, and/or as a continuous operating regime (this is also valid for other software TABs). Of course, this is not valid for other setting parameters that are not establishing/defining basic operating modes.

Auto range: If switch is selected for Auto range (upper position), only frequency ranges given in the software by default will be visible and selectable. If lower switch position is chosen, it is possible to enter manually different frequency and span values.

Range: Operating frequency range for certain ultrasonic load should be selected or typed here.

MIN frequency & MAX frequency: corresponds to end-values of the Start frequency slider (for instance, here 31 and 36 kHz).

MAX Span: By default, automatically, we have 1 kHz wide Max. Span, but manually we can select and type another value. Span is frequency capture interval for resonant regime tracking.

Principal software user-interface for controlling WELDING generators:
 First TAB (basic settings): Welding by Time

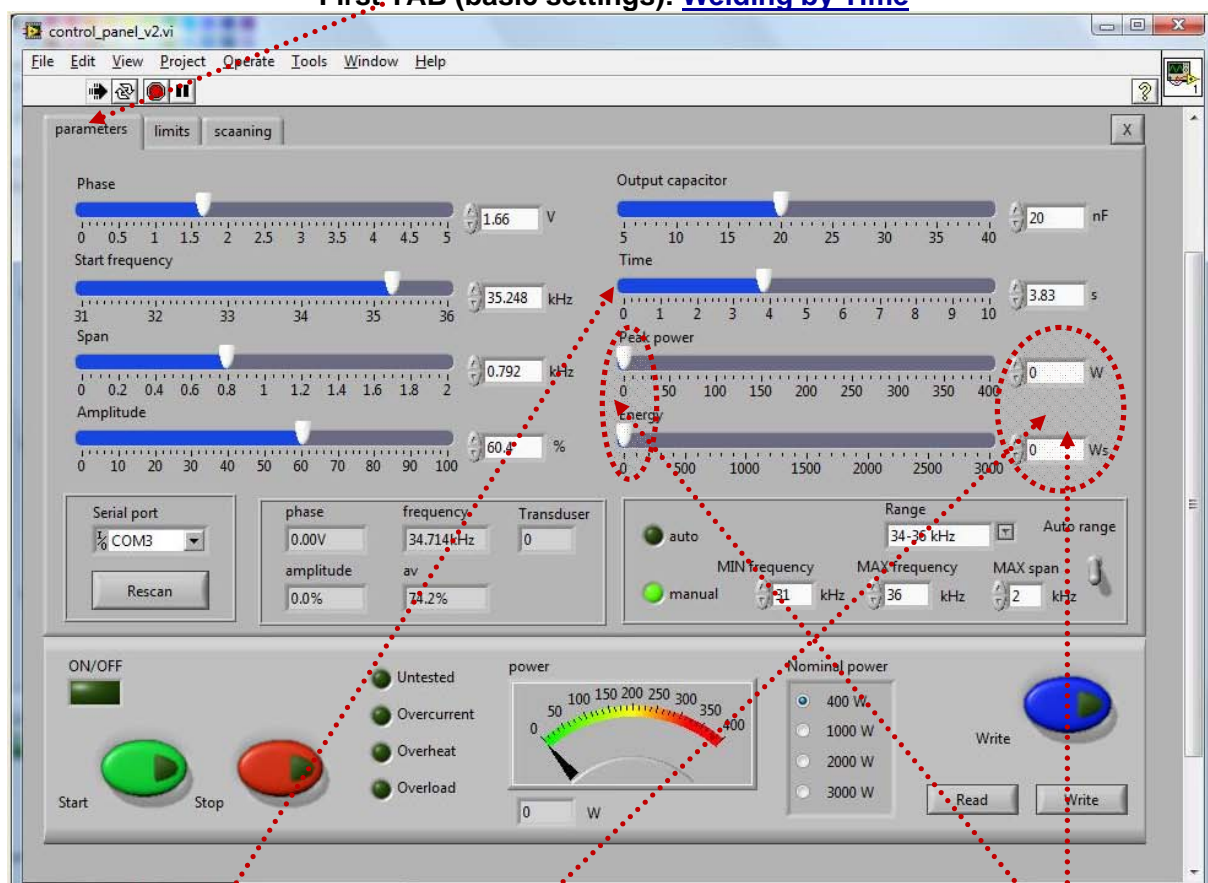

Screen example for “Welding by limiting only a welding time”. Welding process will stop after given Time interval (here 3.83 s). There are no limits for operating Power and delivered Energy (because of zero settings).

Every time when parameters of certain operating-mode variable are set to 0 (zero), like here encircled, the LabVIEW software for ultrasonic generators is considering this as: function not in use, or function without limits, and/or as a continuous operating regime (**this is also valid for other software TABs**). Of course, this is not valid for other setting parameters that are not establishing/defining basic operating modes.

Phase set point, start frequency, compensating capacitance and frequency Span can be later slightly changed in real time, during ultrasonic generator operating high power, until we reach desired operating amplitude regulation, while still keeping automatic phase regulation. These are very important and very useful options.

Literature: [Piezoelectric Transducers Modeling and Characterization \(e-book\)](#)

Principal software user-interface for controlling WELDING generators:
 First TAB (basic settings): Welding by Peak power

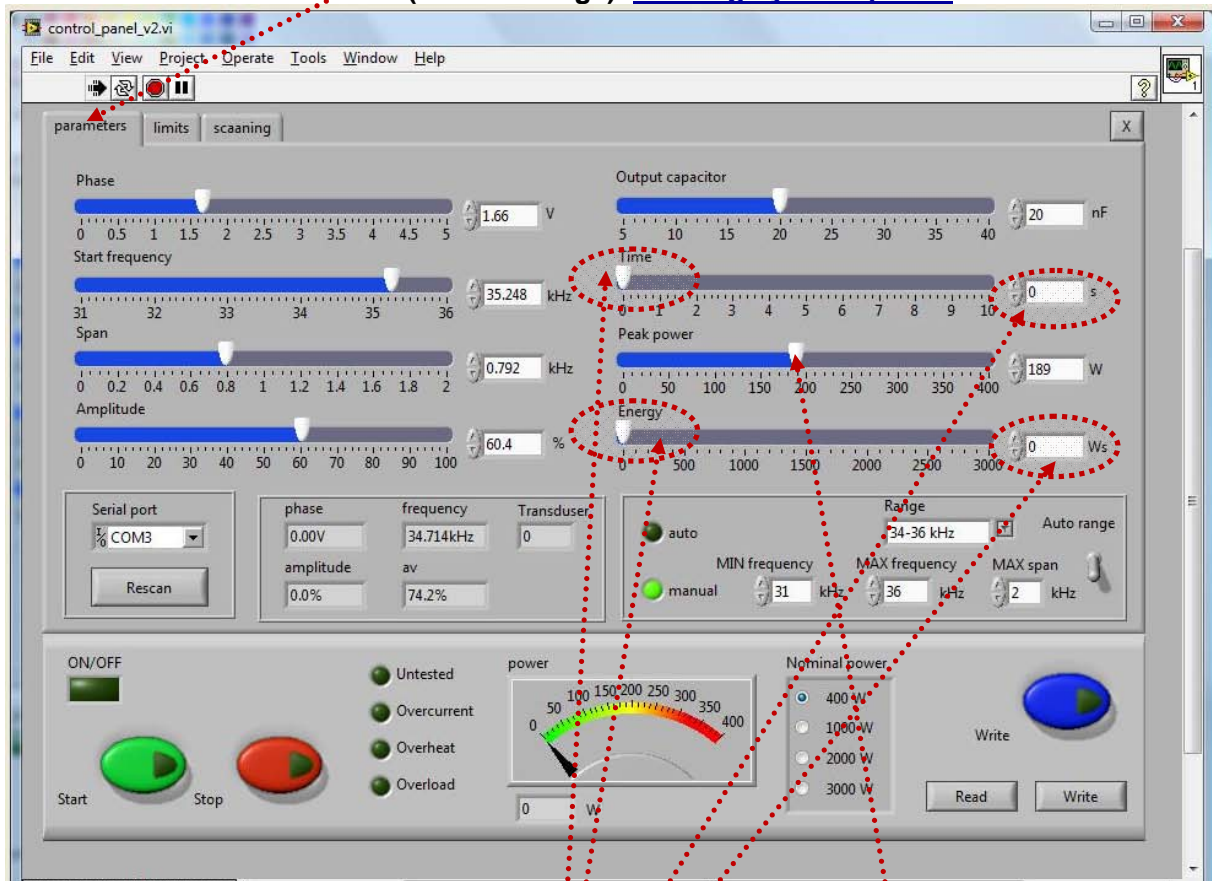

Screen example for “Welding by limiting the Peak power on the load”. Welding process will stop when Peak power is reached (here 189 W). There are no limits for total operating Time and delivered Energy (because of zero settings). Every time when parameters of certain operating-mode variable are set to 0 (zero), like here encircled, the LabVIEW software for ultrasonic generators is considering this as: function not in use, or function without limits, and/or as a continuous operating regime (this is also valid for other software TABs). Of course, this is not valid for other setting parameters that are not establishing/defining basic operating modes.

Principal software user-interface for controlling WELDING generators:
 First TAB (basic settings): Welding by delivered Energy

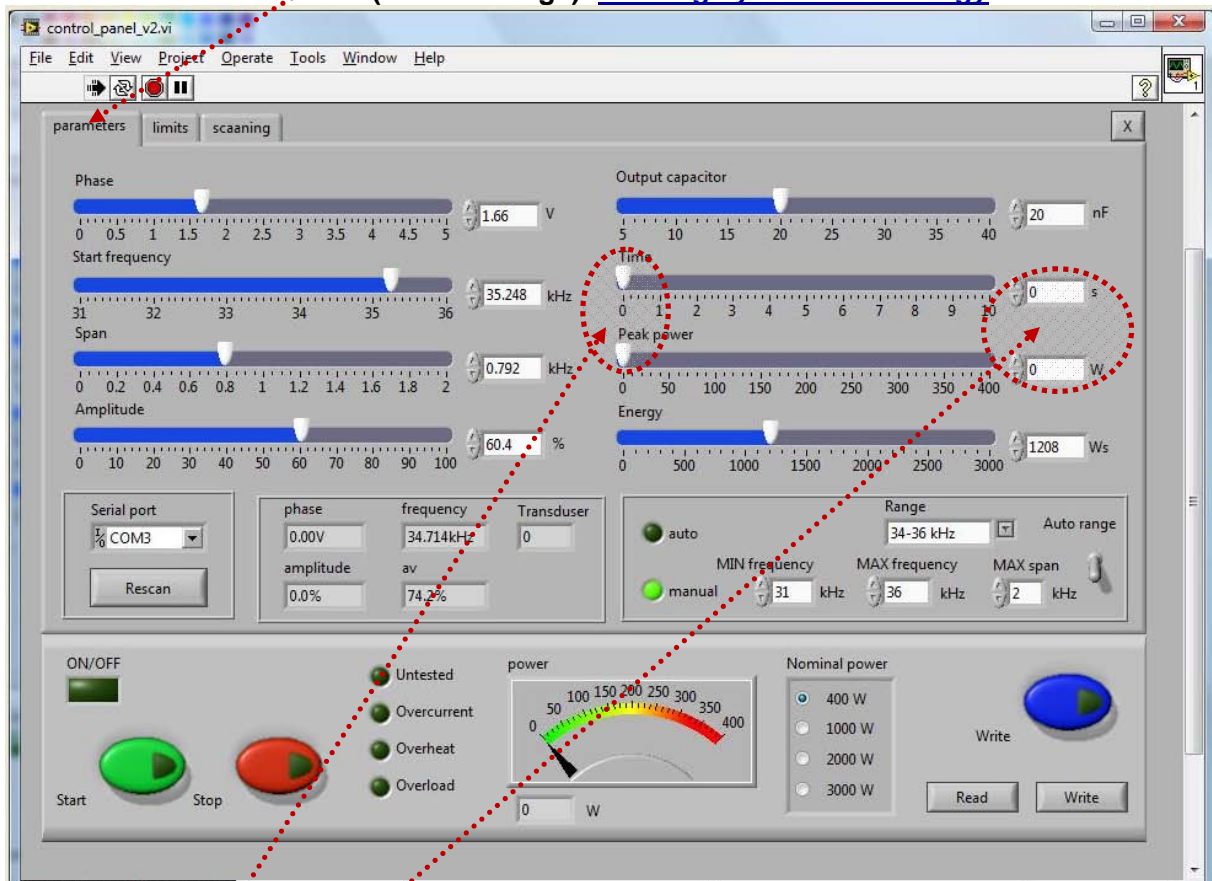

Screen example for "Welding by limited amount of Energy" which should be sent to a load. Welding process will stop when given amount of Energy is delivered to a load (here 1208 Ws). There are no limits for total operating Time and operating Peak power (because of zero settings). Every time when parameters of certain operating-mode variable are set to 0 (zero), like here encircled, the LabVIEW software for ultrasonic generators is considering this as: function not in use, or function without limits, and/or as a continuous operating regime (this is also valid for other software TABs). Of course, this is not valid for other setting parameters which are not establishing/defining basic operating modes. For this operating mode Time and Peak power should always be set to 0 (zero), because if we set either Time or Peak power to other non-zero values, Energy mode will be deactivated.

Principal software user-interface for controlling WELDING generators: **Second TAB** setting of basic operating intervals, boundary conditions and limitations: **Welding by delivered Energy**. Here, delivered energy amount is defined (limited) on the first TAB, and setting limits on this TAB are only **Peak Power and Time**.

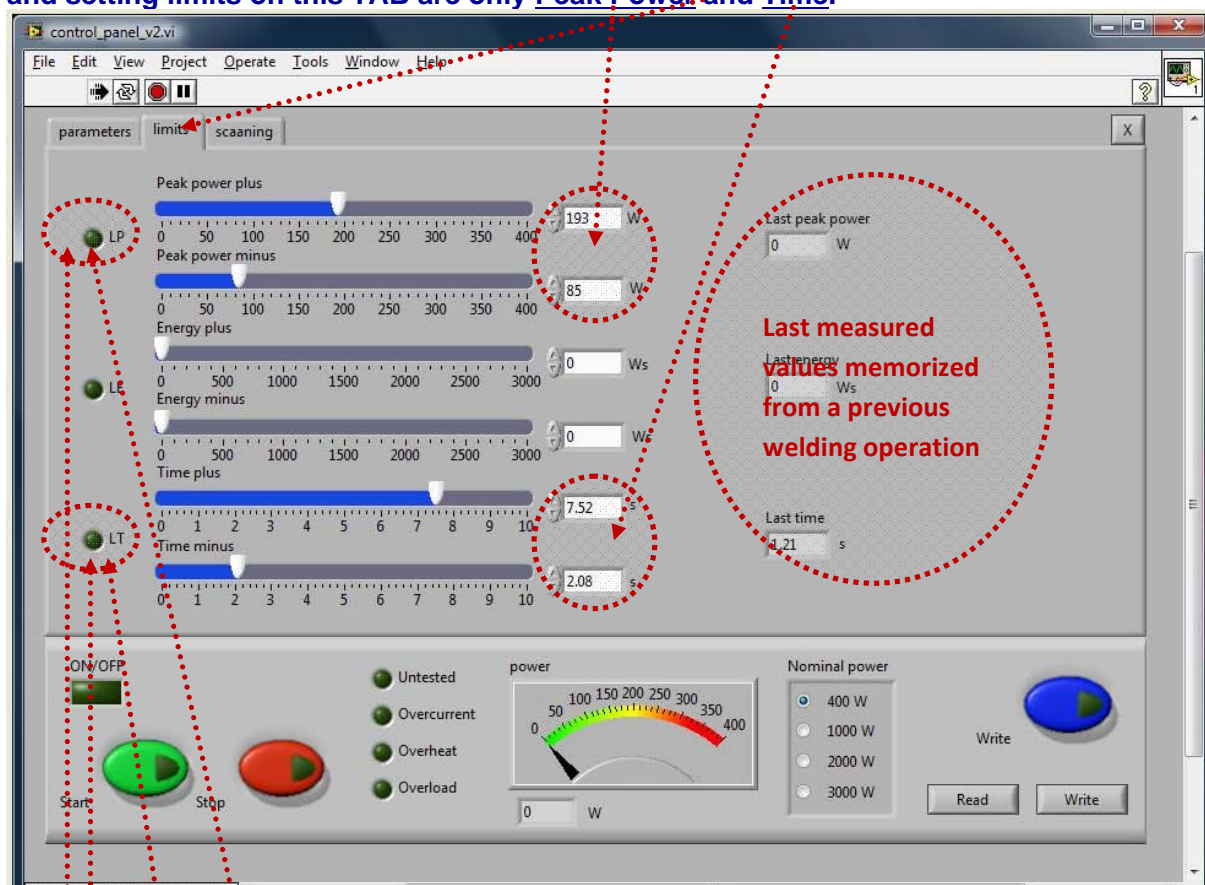

Peak power plus (=) maximal allowed Peak power which can drive a load (here 193 W). If real, actual load **Peak power** would be for some reason higher than **Peak power plus**, generator will produce **error message** on the front panel of generator box and **on the software user interface**.

Peak power minus (=) minimal allowed **Peak power** which can drive a load (here 85 W). If real, actual load **Peak power** would be for some reason lower than **Peak power minus**, generator will produce **error message** on the front panel of generator box and **on the software user interface**.

Time plus (=) maximal allowed operating time which can drive a load (here 7.52 s). If real **operating time** would be for some reason higher than **Time plus**, generator will produce **error message** on the front panel of generator box and **on the software user interface**.

Time minus (=) minimal allowed **operating time** which can drive a load (here 2.08 s). If real, actual load **operating time** would be for some reason lower than **Time minus**, generator will produce **error message** on the front panel of generator box and **on the software user interface**.

Principal software user-interface for controlling WELDING generators: Second TAB setting of basic operating intervals, boundary conditions and limitations: Welding by Peak Power. Here, operating Peak power is defined (limited) on the first TAB, and setting limits on this TAB are only Energy and Time.

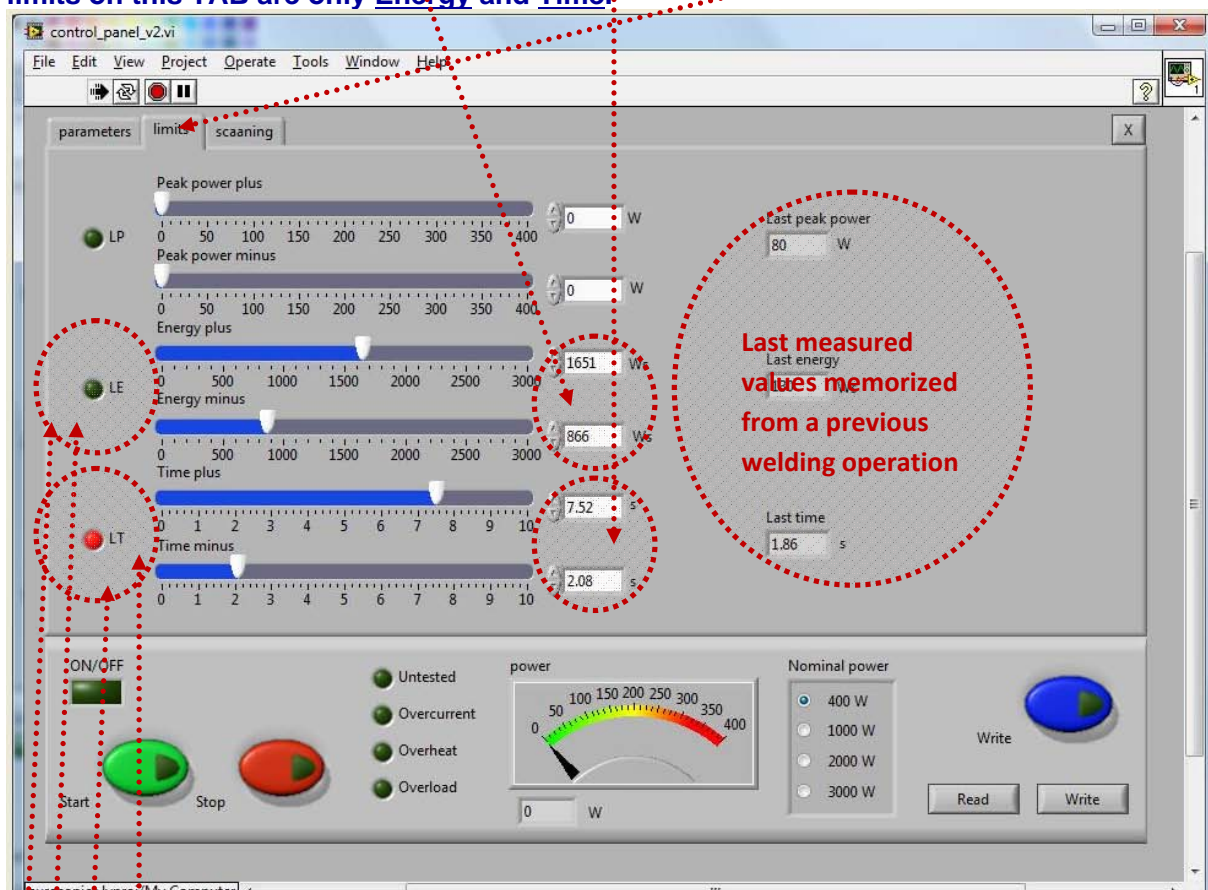

Energy plus (=) maximal allowed Energy which can drive a load (here 1651 Ws). If real load Energy would be for some reason higher than Energy plus, generator will produce error message on the front panel of generator box and on the software user interface.

Energy minus (=) minimal allowed Energy which can drive a load (here 866 Ws). If real load Energy would be for some reason lower than Energy minus, generator will produce error message on the front panel of generator box and on the software user interface.

Time plus (=) maximal allowed operating time which can drive a load (here 7.52 s). If real operating time would be for some reason higher than Time plus, generator will produce error message on the front panel of generator box and on the software user interface.

Time minus (=) minimal allowed operating time which can drive a load (here 2.08 s). If real, actual load operating time would be for some reason lower than Time minus, generator will produce error message on the front panel of generator box and on the software user interface.

PHASE-FREQUENCY SCANNING: Third TAB

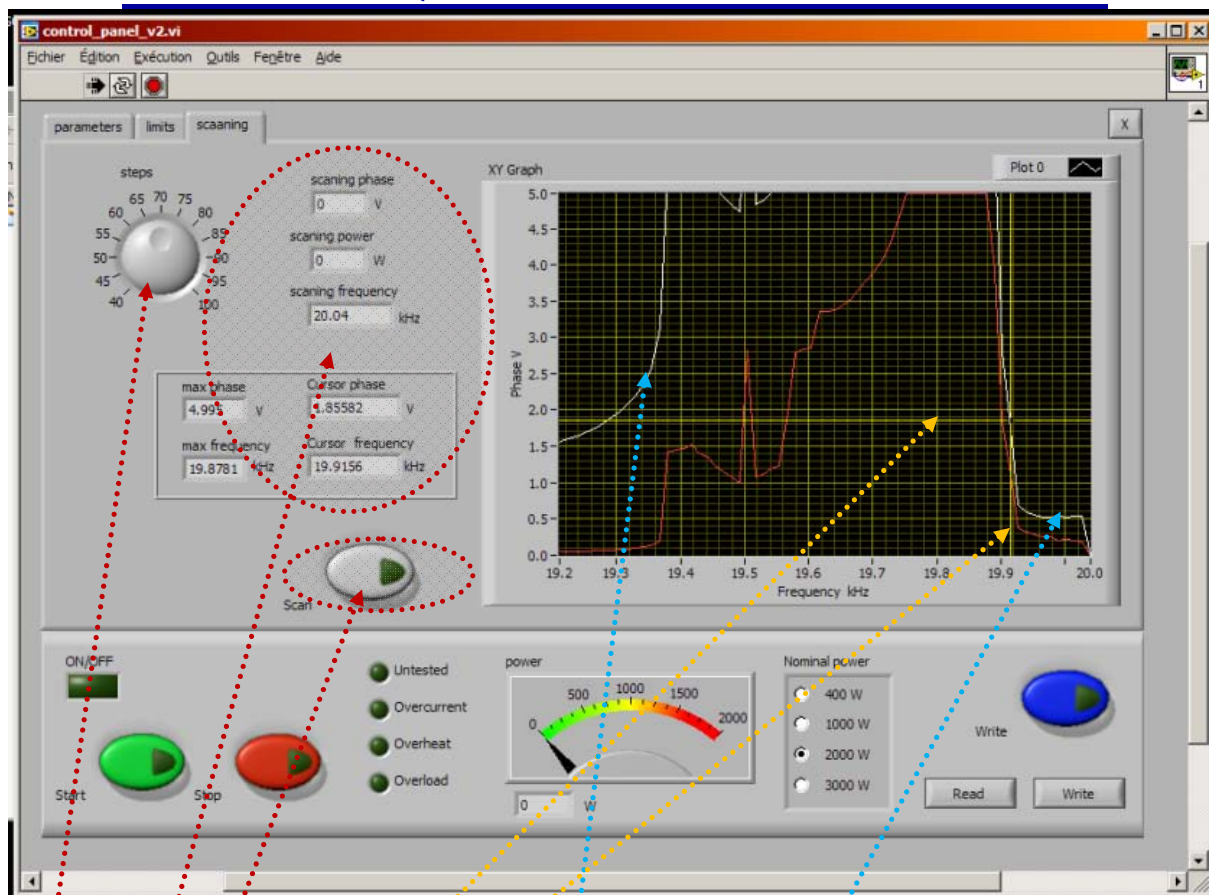

Principal software user-interface for controlling WELDING generators: Third TAB

Steps: Number of measured or scanning points (max. 100).

Numerical indicators: All numerically visible values correspond to what we see on the **right side screen**.

Max. phase: Extreme, measured phase (upper phase value). **Phase (=) red color curve**

Max. frequency: This is the frequency which corresponds to **Max. phase** value (in reality this is parallel resonant frequency).

Cursors: Can be visualized and moved/dragged by mouse on the **right side, scanning screen**.

Scan: By pressing this button, phase-frequency scanning is activated. In order to find optimal operating frequency range (Span), it is necessary to apply LabVIEW software scanning (right side of the software screen). **When applying software scanning it is important that ultrasonic load is operating in air (being not loaded).**

Corrected effective phase: **(=) white color curve**

Before analyzing/scanning and using **frequency-phase tracking mode**, select proper operating **frequency range**, which corresponds to a known operating frequency range of ultrasonic transducer (or load)? Elliptically encircled setting zones (of LabVIEW software MPIwelding.exe) are not used in a resonant “**frequency-phase**” tracking mode. **When performing low power scanning (using our LabView software), in order to find or estimate optimal frequency range of certain transducer, compensating capacitance should be set on minimum (= 5 nF).**

Save/Write inside of the generator memory (last operating situation). Save/Write settings as any computer file.

Low Power Scanning or “Frequency-Phase” measuring mode is the safe-operating, low-power frequency scanning of ultrasonic load (Ultrasonic converter + booster + sonotrode + etc.), where the scanning display would visualize the phase difference between a load current and load voltage versus frequency (**red color curve**), and Effective, corrected Phase curve (**white color curve**). Such frequency scanning is realized using the LabView software (**MPIwelding.exe**) supplied with ultrasonic generator). In order to make scanning, personal computer with installed Lab View software should be connected to ultrasonic generator through RS485 interface. **When applying software scanning (or frequency-phase tracking) it is recommendable to make scanning when ultrasonic load is operating in air (being not loaded), and later to make the same scanning when transducer is loaded (and to compare results, which should be mutually similar).**

Initially (first safe operating, low power frequency scanning) should be selected to cover only the expected operating frequency range of ultrasonic system. For instance, if we know the series and parallel resonant frequency of certain transducer (measured by impedance analyzer), selected scanning frequency interval should be little bit wider and overlap both series and parallel resonant frequencies.

In here-described scanning, frequency is smoothly changing towards lower values, starting from f-start (which is higher than parallel resonant frequency) and finalizing scanning at the frequency that is equal to f-start – **Span**. Span is the frequency interval we select as a frequency-capture range (in Lab View Software).

For instance, if ultrasonic system consists of 20 kHz ultrasonic converter + 20 kHz booster + 20 kHz sonotrode (where not all of them are exactly tuned to operate on 20 kHz, or have single operating frequency of 20 kHz), we know that we should expect the resulting, central operating frequency of such system to be somewhere close to 20 kHz. Consequently, we could select the scanning frequency range to be between 20 and 21 kHz (meaning f-start = 21 kHz, and **Span** = 1 kHz). Of course, another relevant example could be to select such frequency scanning between 19.5 kHz and 20.5 kHz (meaning f-start = 20.5 kHz, Span = 1 kHz). Later (during scanning), the Lab View software will search and find real, average operating frequency somewhere inside of the area covered by scanning).

In the next step (next safe-operating frequency scanning) we should select new (shorter) value for Span to cover only the central part of the phase curves (both, red and white color curves). New f-start will be again at the point where the phase curve is minimal (meaning closer to parallel resonance).

This way, we will visualize mentioned part of the phase difference curve on a larger display, and we will be able to estimate the frequency which is in the middle of that frequency interval, and which is

approximately equal: $f\text{-start} - 0.5(\text{Span})$. Later, real operating frequency regime (under automatic effective phase regulation, found by internally implemented hardware and software) will find its average or effective operating frequency (inside of the new Span interval) and we will be able to perform/set large frequency sweeping around that frequency (in both directions).

1. For safety reasons, when ultrasonic system is started first time, when (any or all of): ultrasonic transducer, booster, sonotrode and output sonotrode-tool are unknown, or new, or replaced, set a low **Amplitude** value (20%, for instance).

Later, after scanning and proper operating regime is found (when proper $f\text{-start}$ is found); -power level can be readjusted (if necessary). **Start frequency $f\text{-start}$ can be changed/adjusted also during the generator operation.** The generator has an automatic “frequency tuning” inside the frequency capture range (see the explanation that follows). The **frequency capture range** can be set by “**Span**” parameter from 0 to 1 kHz (below the start frequency, towards lower frequencies: $f\text{-capture} = f\text{-start} - \text{Span}$). If we set $\text{Span} = 0$, generator will not search for optimal operating frequency between Series and Parallel resonances (and generator will operate in a relatively fixed and **forced**, non-resonant, not automatically controlled oscillating regime, with fixed and forced frequency sweeping, regardless of impedance characteristics and natural resonant frequencies). In such situations, we can set start frequency anywhere we like (no automatic regulation).

The operating resonant frequency of ultrasonic system must be found in advance (before operating the system full power), performing initial low power scan testing with the generator LabVIEW software. This frequency will be found somewhere below the frequency where scanned generator current is maximal, and where the scanned phase function is smoothly rising from its minimal value towards its maximum, when in the same time, the frequency is going towards lower frequencies). The frequency area which is covered (by this type of regulation) depends on the device type (it is impedance-characteristic dependent: $f\text{-capture} = f\text{-start} - \text{Span}$).

Initially (first safe-operating, low-power frequency scanning) should be selected to cover only the expected operating frequency range of ultrasonic system (**Span**).

Initial Start frequency and **Span** can be adjusted on the left side of the software screen (see the picture below).

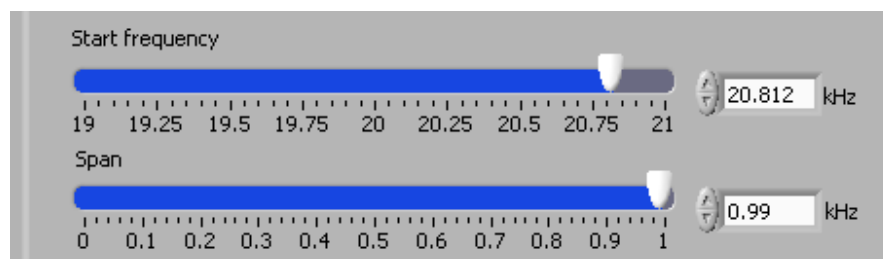

In here-described scanning, frequency is smoothly changing towards lower values, starting from f-start and finalizing scanning at the frequency which is equal to f-start – Span. **Span** is the frequency interval we select as a frequency-capture range (in LabVIEW Software).

For instance, if ultrasonic system consists of: 20 kHz ultrasonic converter + 20 kHz booster + 20 kHz sonotrode + 20 kHz sonotrode-tool (where not all of them are exactly tuned to operate on 20 kHz, or to have single operating frequency of 20 kHz), we know that we should expect the resulting, central operating frequency of a sonotrode-tool to be somewhere close to 20 kHz, and consequently, we could select the initial scanning frequency range to be between 20 and 21 kHz (meaning f-start = 21 kHz, and Span = 1 kHz). Of course, another relevant example could be to select such frequency scanning between 19.5 kHz and 20.5 kHz (meaning: f-start = 20.5 kHz, Span = 1 kHz).

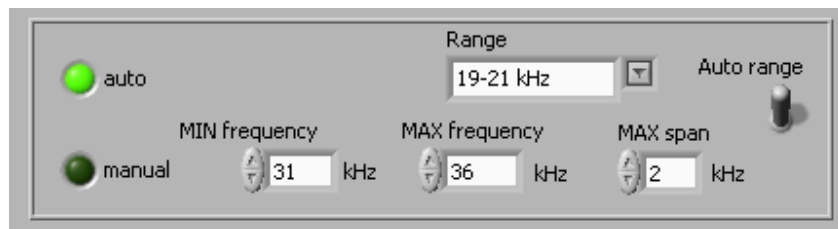

Later (during scanning), the Lab View software will draw the Phase characteristics (versus frequency) inside of the area covered by scanning (by **Span**).

2. On the lower right side of the third TAB, there is the **Scan** button, which is activating the safe-operating, low power ultrasonic load scanning (kind of load impedance scanning). Before **Scan** is activated, it is important to select scanning frequency resolution (number of **steps**), which is selectable from 40 to 100. See **Scan** and **steps** positions on the picture, below.

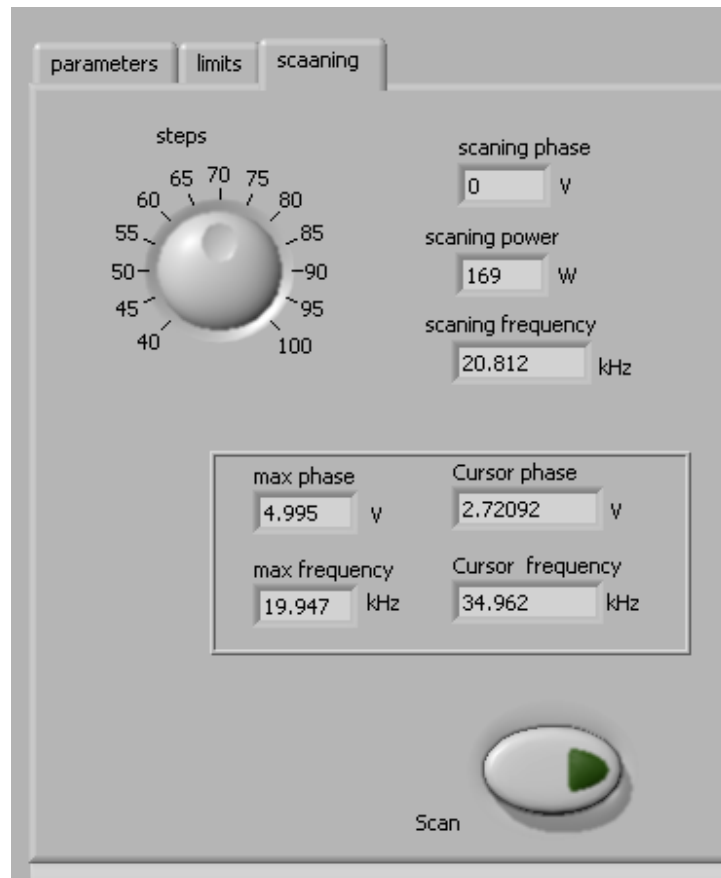

After certain time scanning will stop and on the upper right corner of the user-software interface we will see the plots of scanned phase (red color curve) and effective, corrected phase (white color curve). A typical scanning screen is presented on the picture below (Span is well selected, capturing the area of both series and parallel resonant frequencies, and wider).

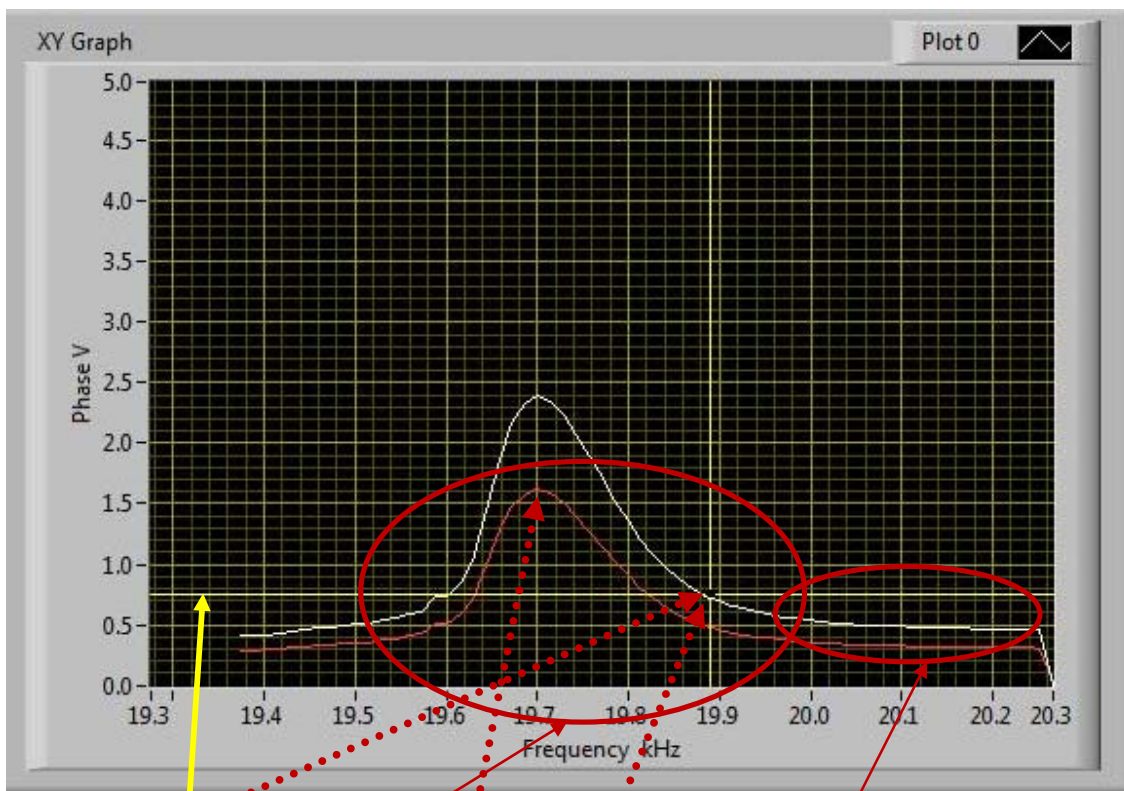

Relevant, most probable operating point, which is good for automatic frequency and phase regulation; on the white color curve).

Real phase curve (red color curve; has only informative meaning to recognize where the well operating frequency interval is). White and red phase curve should be seen on a similar way, together (in any other case).

In this frequency frequency-capture area (here from 19.5 until 20 kHz) converter will be operational and automatically regulated by ultrasonic generator under different dynamic, loading conditions. Series and parallel resonances are inside the encircled area (not visible on this scanning plot, but if measured by Impedance Analyzer, would be here).

This is the most probable and expected phase level (phase set point) that will be regulated by ultrasonic generator (here about 0.75 V). We are intentionally selecting such smooth, linear phase area, since such areas are easy for automatic regulation. Yellow horizontal and vertical lines are manually moveable cursors that are useful for estimating and marking most probable operating phase and frequency (where automatic regulation will be optimal).

In this frequency area we should select the Start frequency: f_{start} . Ultrasonic generator will start operating from selected start frequency and very fast find its optimal resonant frequency that is under automatic regulation, here. If converter is operating in air, this frequency will be very close to its parallel resonant frequency.

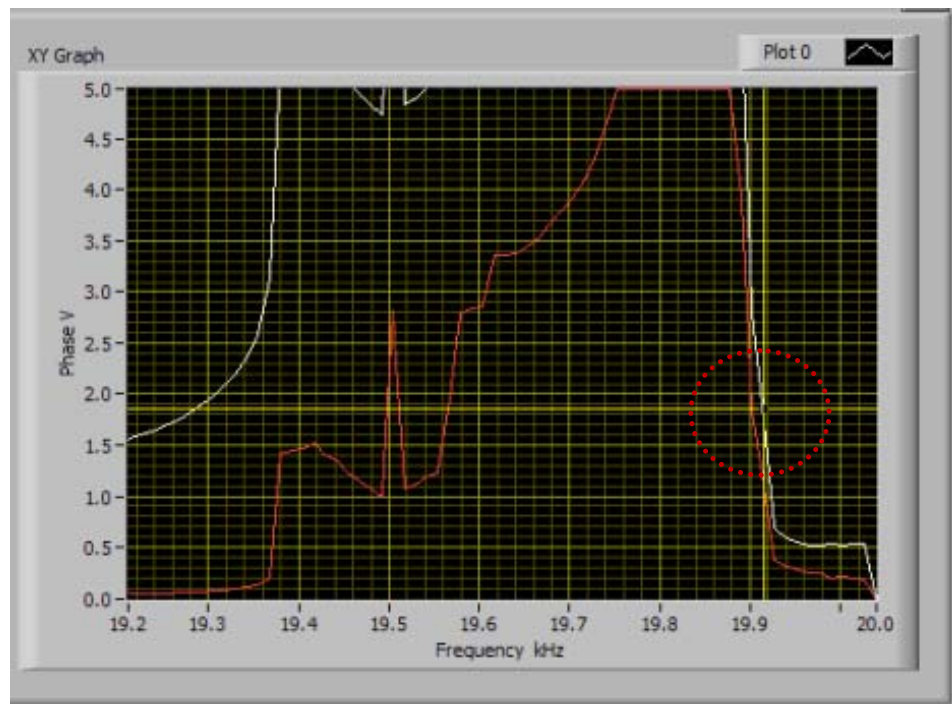
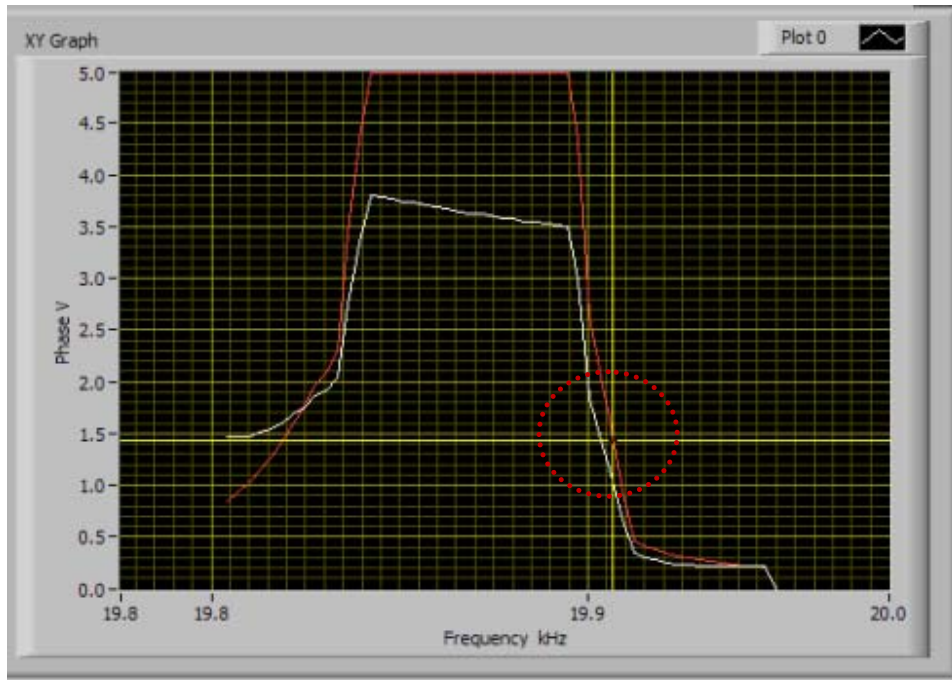

Two examples (different piezoelectric converters) of properly selected phase set point that will be automatically regulated.

3. Find proper resonant mode and start frequency f_{start} by measuring Impedance-Phase-Frequency characteristics using Lab View software (as already explained). Have in mind that initial resonant frequency characteristics will change after certain time, because of ultrasonic oscillations and involved materials aging and stabilization (stress relief, friction between contact surfaces, thermal aging, operating temperature...). Also, resonant frequencies will be very much operating-temperature dependent (converter and sonotrode could heat during operation). Repeat scanning of phase-frequency characteristics after certain time, or in case of noticing problems during ultrasonic oscillations (maybe resonant characteristics are significantly changed and new generator settings should be applied).
4. **Set the “PHASE” initial value (first bar) in the range from 0.5 to 3V** (ideally and preferably below 2.5 V, because maximal phase comparator DC voltage is 5 V (= +90°); -see the picture below). Do not start the generator until all initial settings are verified and sett to safe (low power and low risk) positions.

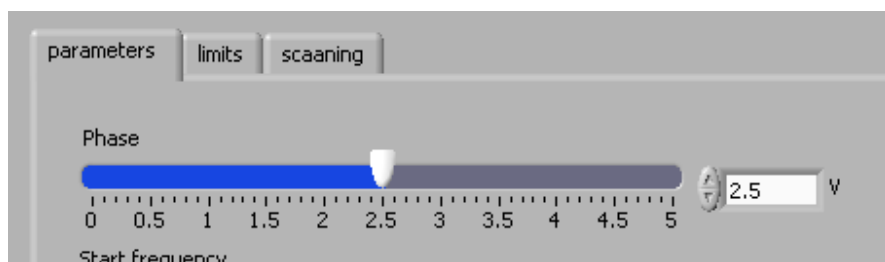

5. After all initial settings are made, Ultrasonic Generator can be activated (from a PC), and it will start driving ultrasonic converter by pressing **Start** (see the picture below). First press on the **Start** button will find and memorize the proper, **average operating frequency**, which corresponds to the selected **effective phase-difference** value. Generator will operate low power, very short time, and stop. In the second activation of the **Start** button, generator will start operating with selected settings (regulating amplitude, phase and frequency).



6. After all settings are tested, we can transfer them to the generator internal memory by using the **Write** button (see below). This is very important operation, because all software settings are still virtual, and present only in the LabVIEW software (on a PC screen), until we transfer them to the internal memory of the generator.



7. Generator can be controlled either manually (rotary encoder + LCD) or from a PC (but not in the same time from both of them).

Read – Write options: After all settings are properly and optimally made, we can save the file with such settings using **Write** button (like saving any PC file). Later, we can simply invite/**Read** one of such files (for a specific load) and WELDING generator will start operating as previously memorized.

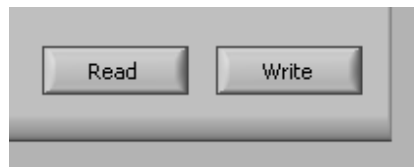

av (%): Is the actuator value of the automatic (closed loop regulator) for **effective phase**. This is real time indicator. Ideal situation is that **av** is close to 50%, meaning to be somewhere in the linear zone of the **phase curve**.

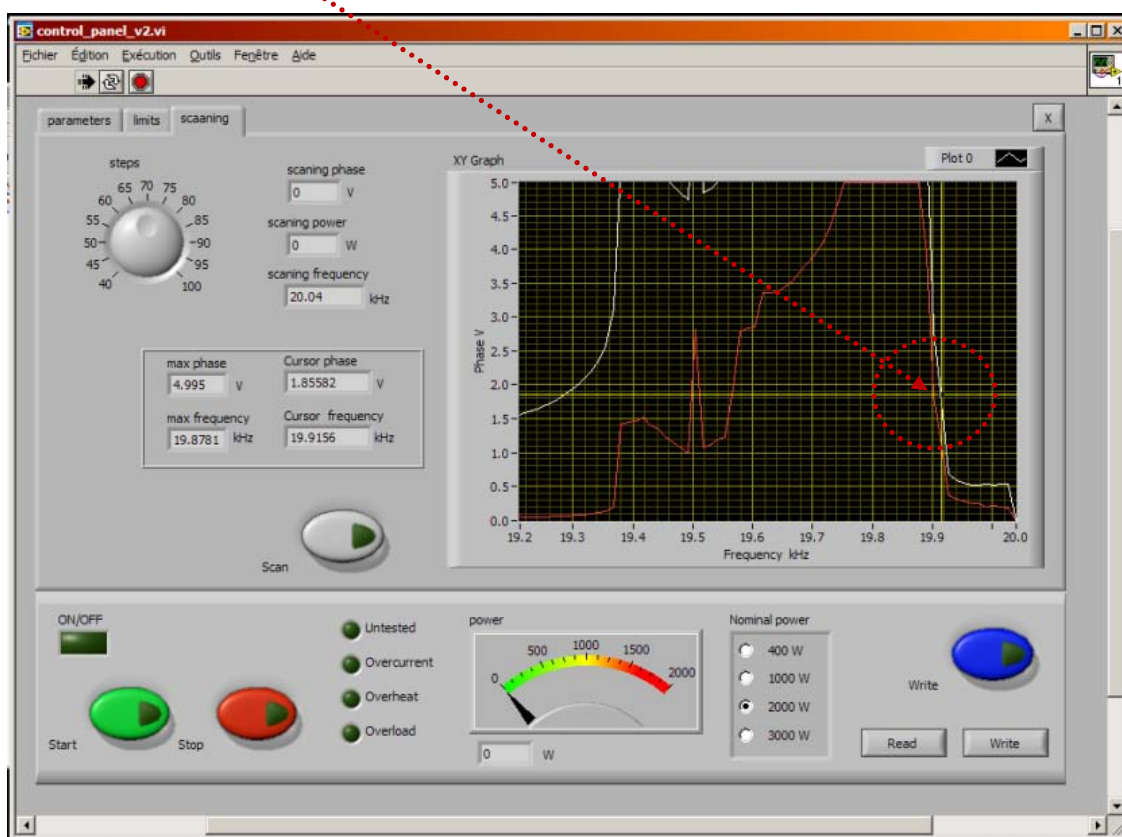

If "**av**" is showing **0** (zero value) this means that starting frequency (f -start) is selected too low. Change f -start and place it slightly higher compared to the value selected before.

If "**av**" is closer to maximal values, either starting frequency is selected too high, or "**Span**" value is not large enough. Change f -start and **Span** value, until getting **av** between 30% and 50%.

Later, after scanning and proper operating regime is found (when proper f -start is found); - sweeping parameters and power level can be readjusted (if necessary). **Phase set point, start frequency and frequency Span can be later slightly changed in real time, during ultrasonic generator operating high power, until we reach desired operating amplitude regulation, while still keeping automatic effective phase regulation. These are very important and very useful options.**

The generator has an automatic "resonant frequency tuning" inside the frequency capture range (see the explanation that follows). The **frequency capture range** can be set by "**Span**" parameter from 0 to 1 kHz (below the start frequency, towards lower frequencies: f -capture = f -start - Span). If we set Span = 0, generator will not search for optimal operating frequency between Series and Parallel resonances (and generator will operate in a relatively fixed and

forced, non-resonant, not automatically controlled oscillating regime, regardless of impedance characteristics and natural resonant frequencies). In such situations, we can set start frequency anywhere we like (no automatic regulation). **Manually, we can select any other Span, which is wider or shorter than 1 kHz (because certain converters will request larger Span values).**

The operating resonant frequency of ultrasonic system must be found in advance (before operating the system full power), performing initial low power scan testing with the generator LabVIEW software. This frequency will be found somewhere below the frequency where scanned generator current is maximal (not visible during scanning), and where the scanned phase function is smoothly rising from its minimal value towards its maximum, when in the same time, the frequency is going towards lower frequencies). The frequency area which is covered (by this type of regulation) depends on the device type (it is impedance-characteristic dependent: $f\text{-capture} = f\text{-start} - \text{Span}$).

Frequency-capture range should be found when generator is performing the safe-operating, low-power frequency scanning of ultrasonic load (Ultrasonic converter + booster + sonotrode + sonotrode-tool), where the scanning display (LabVIEW software) would visualize the effective phase difference between a load current and load voltage versus frequency (white color curve). Such low-power frequency scanning is realized using the LabVIEW software supplied with ultrasonic generator). In order to make scanning, personal computer with installed Lab View software should be connected to ultrasonic generator trough RS485 interface as explained before.

Initially (first safe-operating, low-power frequency scanning) should be selected to cover only the expected operating frequency range of ultrasonic system (**Span**); -to cover frequency area of both series and parallel resonant frequencies.

The ideal situation is to have network-impedance analyzer and measure Impedance-Phase-frequency curves in order to find series and parallel resonant frequency of the converter. Later, we will select Span that should cover the frequency area that is little bit larger than zone covered by series and parallel resonant frequency. For instance, if certain converter has series resonance on 19 kHz, and parallel resonance on 21 kHz, we can select Span which will cover the area from 18.5 until 21.5 kHz.

Initial Start frequency and **Span** can be adjusted on the left side of the software screen (see the picture below).

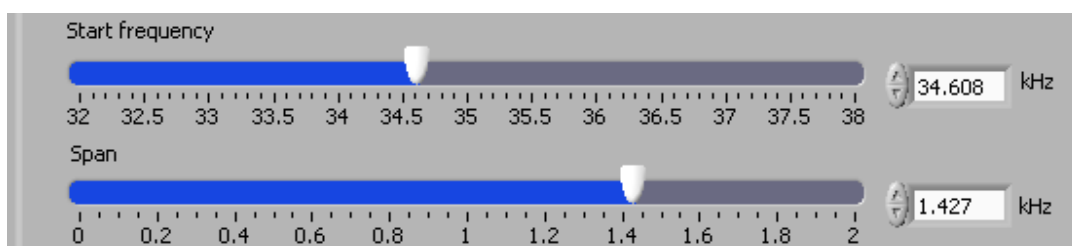

In here-described scanning, frequency is smoothly changing towards lower values, starting from f-start and finalizing scanning at the frequency that is equal to f-start – Span. **Span** is the frequency interval we select as a frequency-capture range (in LabVIEW Software).

For instance, if ultrasonic system consists of: 20 kHz ultrasonic converter + 20 kHz booster + 20 kHz sonotrode + 20 kHz sonotrode-tool (where not all of them are exactly tuned to operate on 20 kHz, or to have single operating frequency of 20 kHz), we know that we should expect the resulting, central operating frequency of a sonotrode-tool to be somewhere close to 20 kHz, and consequently, we could select the initial scanning frequency range to be between 20 and 21 kHz (meaning f-start = 21 kHz, and Span = 1 kHz). Of course, another relevant example could be to select such frequency scanning between 19.5 kHz and 20.5 kHz (meaning: f-start = 20.5 kHz, Span = 1 kHz).

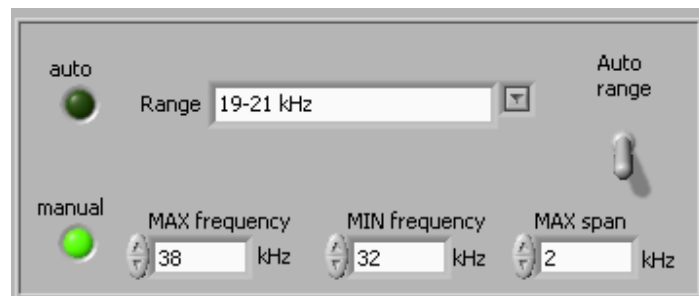

Later (during scanning), the Lab View software will draw the Phase characteristics (versus frequency) inside of the area covered by scanning (by **Span**).

On the lower left side of third scan TAB, there is the **Scan** button, which is activating the safe-operating, low power ultrasonic load scanning (kind of load impedance scanning). Before **Scan** is activated, it is important to select scanning frequency resolution (number of **steps**), which is selectable from 40 to 100. See **Scan** and **steps** positions on the picture, below.

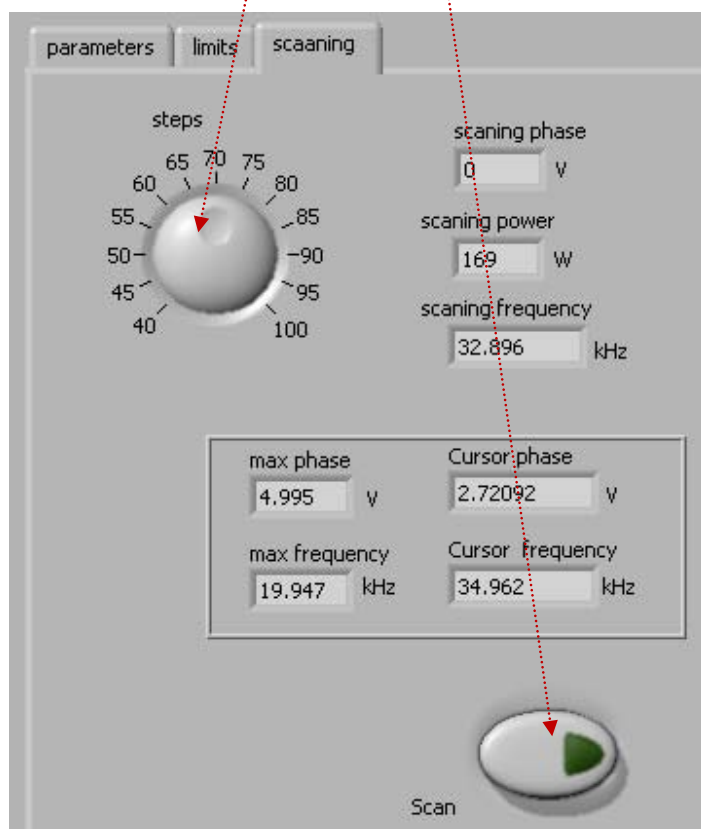

After certain time scanning will stop and on the upper right corner of the user-software interface we will see the plots of scanned phase (red color curve) and Effective, corrected Phase (white color curve). The examples of scanning screen are presented on the pictures below.

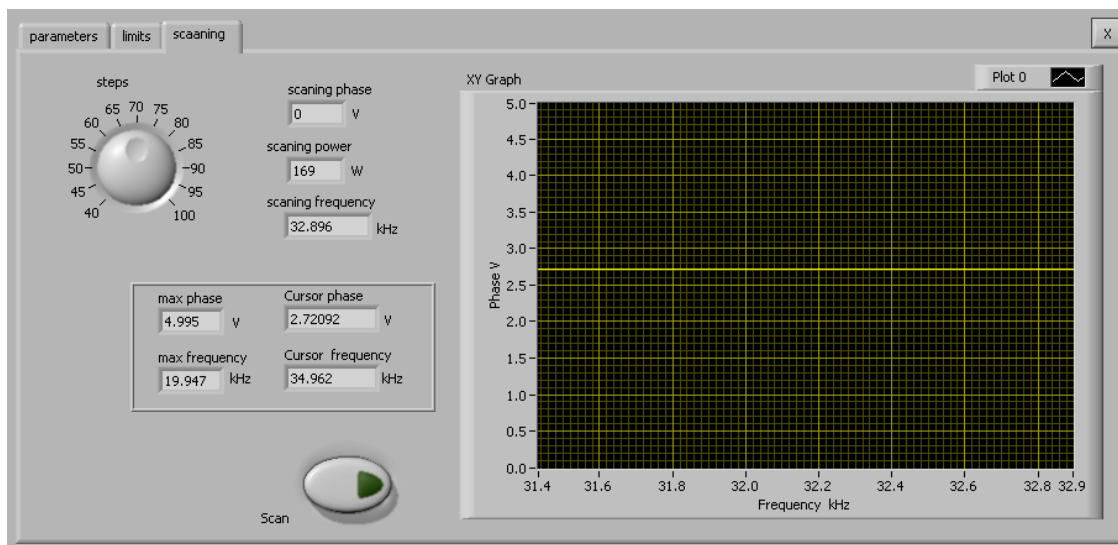

Literature: [Piezoelectric Transducers Modeling and Characterization \(e-book\)](#)

AMMM & Welding Ultrasonic Power Supplies

Examples of proper selection of operating frequency ranges (during Scanning)

If you have impedance analyzer, make impedance measurements and select initial scanning range that will capture both series and parallel resonant frequency and little bit wider (on both sides).

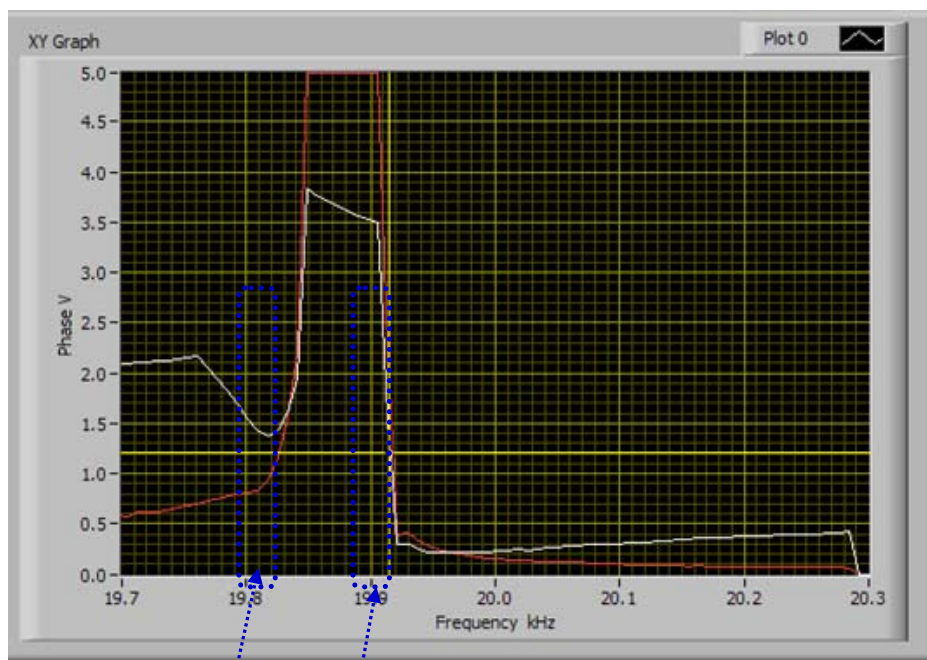

Fig. 1. Typical scanning curve (wide scanning range).

Somewhere in this area is series resonance (here, close to 19.82 kHz)

Somewhere in this area is parallel resonance (here, close to 19.92 kHz)

Before performing scanning, set amplitude to 0 (zero), set output capacitor to minimum (5 nF), set operating mode to "continuous", disable all sweeping parameters (set them to 0), set operating frequency range (minimal and maximal frequency and Span) inside the expected operating frequency interval.

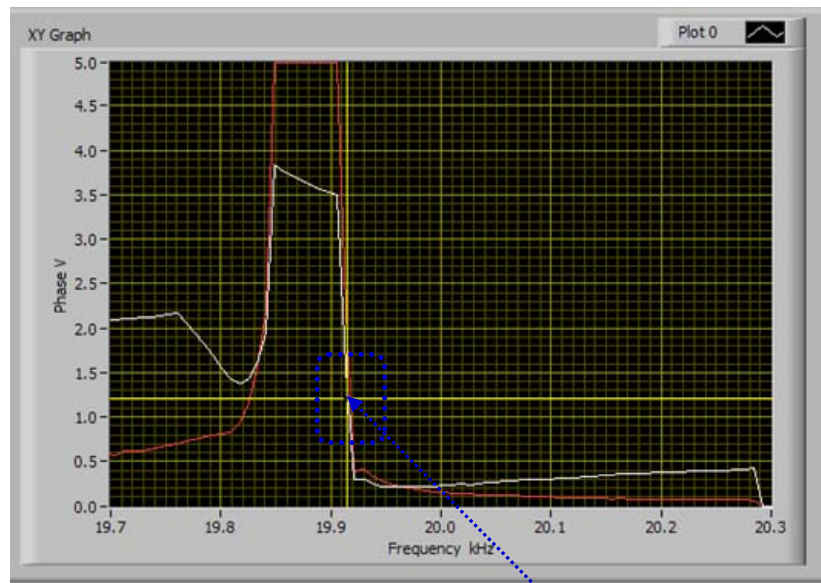

Fig. 2. Typical scanning curve (wide scanning range).

Somewhere in this area, it will be the best to select **set point for phase regulation**. For example, on this curve optimal phase values are between 0.5 and 2 V. Here selected optimum is 1.25 V.

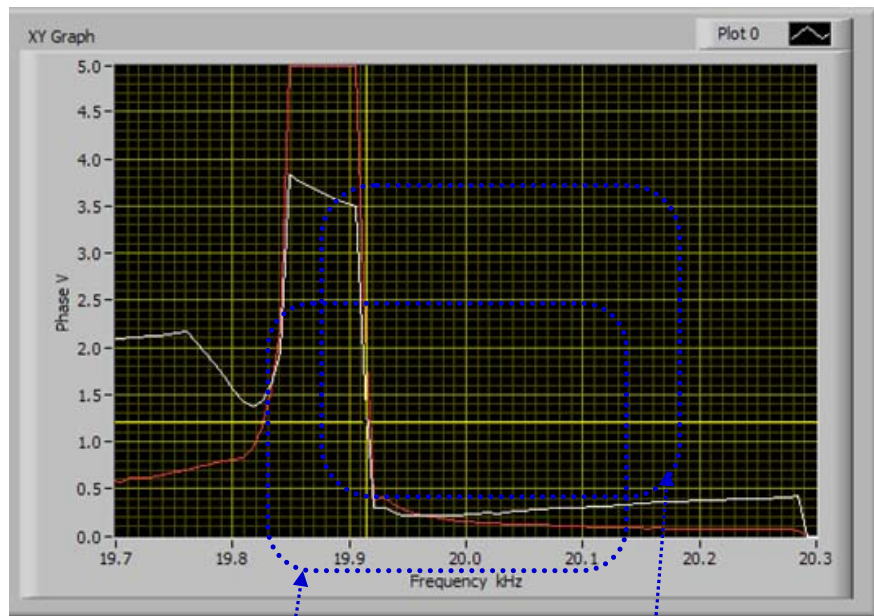

Fig. 3. Typical scanning curve (wide scanning range).

Here is relatively safe operating frequency area. Frequency capture range should be reduced to here-encircled area. For instance, in this case, proper selection for safe operating frequency area is from 19.82 to 20.23 kHz. This is good operating frequency area for very high power plastic welding, Sonochemistry, liquids processing and similar applications. Whenever operating frequency area (or frequency Span) is overlapping series resonant frequency, this presents potentially risky operating regime, which should be well tested. Operating frequency in this area will be automatically regulated from parallel resonant frequency to series resonant frequency and towards lower frequency values.

If we like to select **operating regime only in the close vicinity of parallel resonance,** operating frequency range (and frequency Span) should be selected like here. Series resonance should be excluded by setting minimal frequency (sufficiently high). This will be the safest operating regime for low and moderate acoustic loads, for welding, Sonochemistry, liquids atomizing and powders sieving applications, as well as for operating high amplitude in air. This operating regime has very high oscillating amplitudes and high oscillating velocity.

Here (below series resonance) is **the most powerful, most risky and heavy-duty, high stress operating frequency range**. Converter has increased heat dissipation in this area. Do not operate converter in air or low load conditions, here. Converter should be fully loaded before being activated in this frequency area. Avoid operating in this area whenever possible and not absolutely necessary.

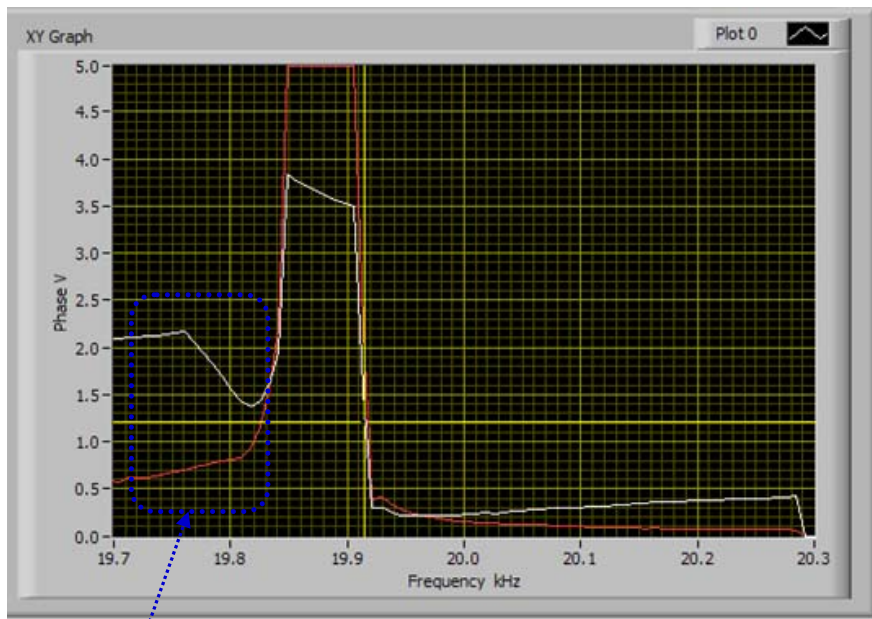

Fig. 4. Typical scanning curve (wide scanning range).

Here is very risky frequency area (high stress, high amplitude, increased converter heating, high oscillatory pressure). Better to avoid this area. This is the area below series resonant frequency. Be very careful if operating in this area. **Operate here only under heavy loading (not in air)**, like in cases of metal welding applications.

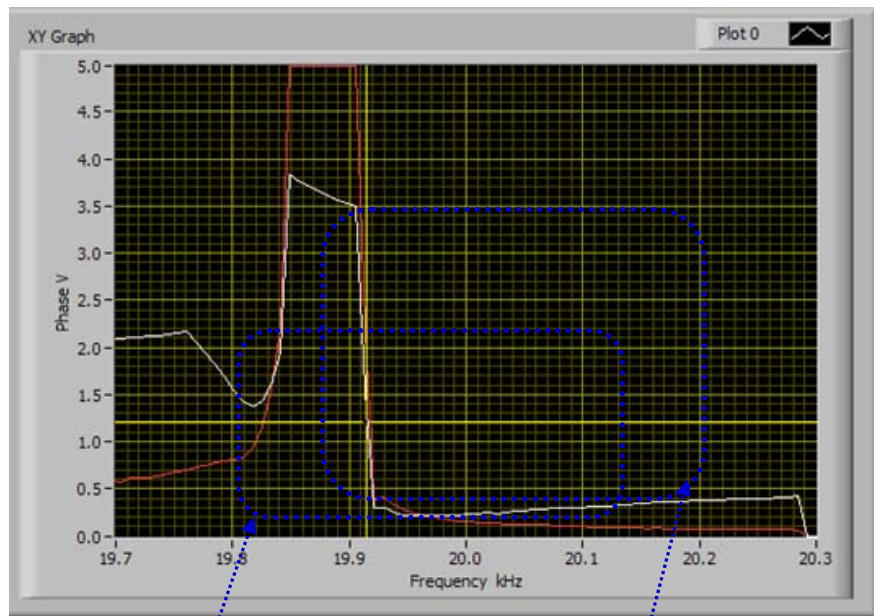

Fig. 5. Typical scanning curve (wide scanning range).

Select this **frequency area for heavy-duty operations under loading** (like metals welding). Here selected frequency range is from 19.79 to 20.21 kHz. **Do not operate in air.** Whenever operating frequency area (or frequency Span) is overlapping series resonant frequency, this presents potentially risky operating regime, which should be well tested. Operating frequency in this area will be automatically regulated from parallel resonant frequency to series resonant frequency and towards lower frequency values.

Select the frequency interval that covers only parallel resonance and higher frequencies, and does not cover series resonance. **This is the safest operating regime for low and moderate acoustic loads**, for welding, Sonochemistry, liquids atomizing and powders sieving applications, as well as for operating high amplitude in air. This operating regime has very high oscillating amplitudes and high oscillating velocity.

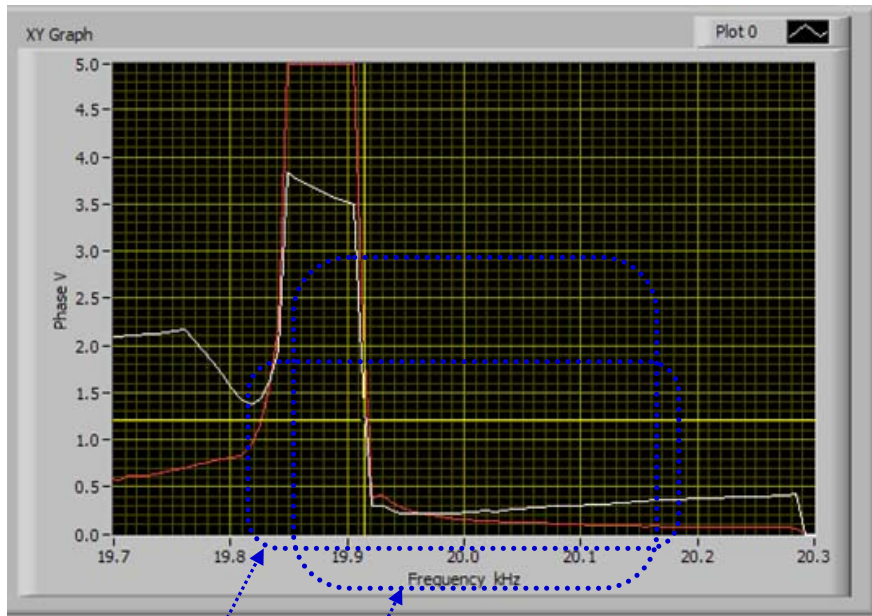

Fig. 6. Typical scanning curve (wide scanning range).

Select this **frequency area for continuous operating under moderate and high power loading** (like for welding and liquids processing). Here selected safe frequency range is from 19.84 to 20.3 kHz.

Select the frequency interval that covers only parallel resonance and higher frequencies, and does not cover series resonance. **This is the safest operating regime for low and moderate acoustic loads**, for welding, Sonochemistry, liquids atomizing and powders sieving applications, as well as for operating high amplitude in air. This operating regime has very high oscillating amplitudes and high oscillating velocity.

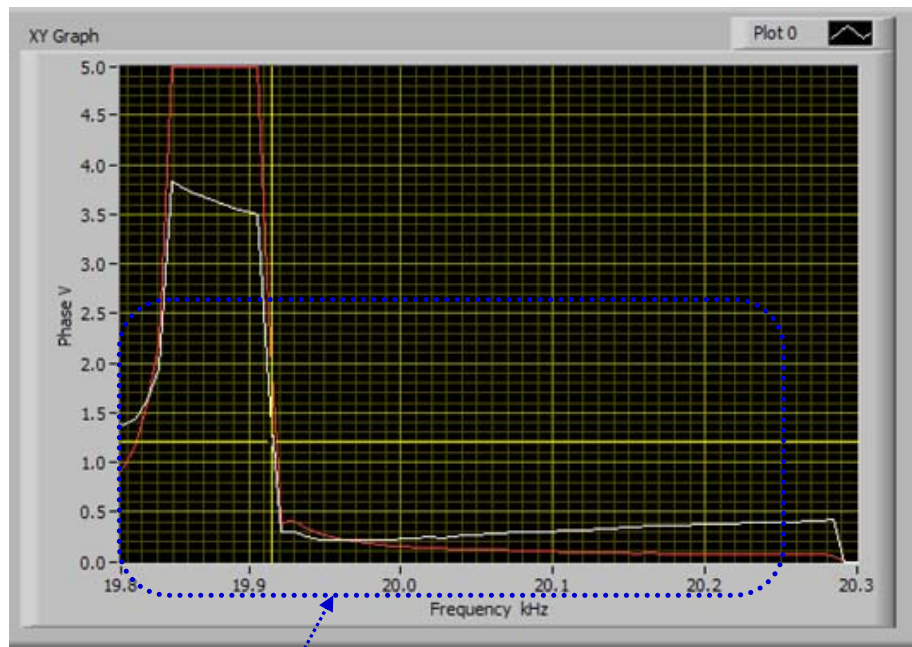

Fig. 7. Typical scanning curve (optimal, safe operating range).

Here is **well-selected (total), safe frequency capture and regulation area for most of high power welding and liquid processing applications.** Whenever operating frequency area (or frequency Span) is overlapping series resonant frequency, this presents potentially risky operating regime, which should be well tested. Operating frequency in this area will be automatically regulated from parallel resonant frequency to series resonant frequency and towards lower frequency values.

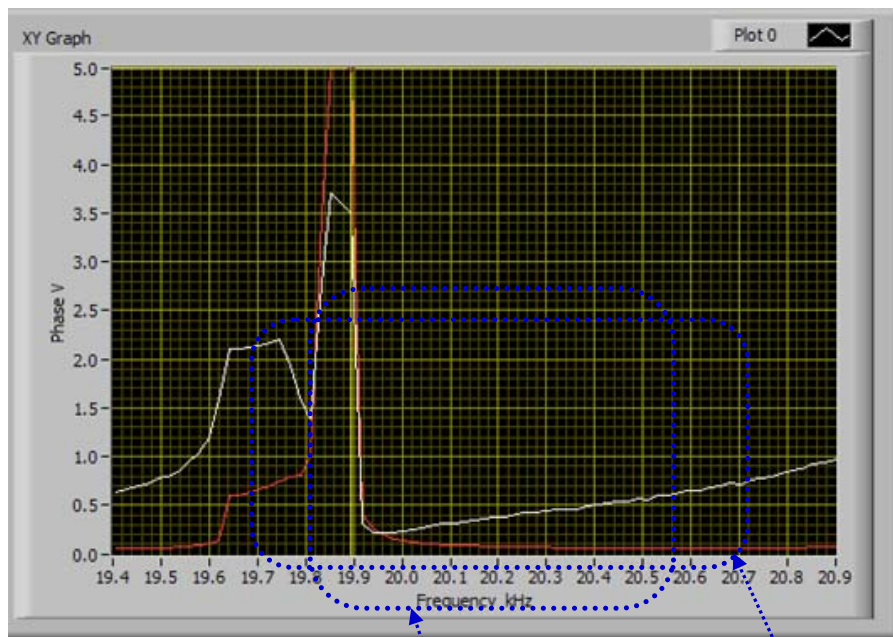

Fig. 8. Another example of very wide frequency interval scanning

Well selected frequency capture area for most of moderate and high power applications.

Frequency area for metals welding and other heavy-duty applications under loading (do not operate in air).

Whenever operating frequency area (or frequency Span) is overlapping series resonant frequency, this presents potentially risky operating regime, which should be well tested. Operating frequency in this area will be automatically regulated from parallel resonant frequency to series resonant frequency and towards lower frequency values.

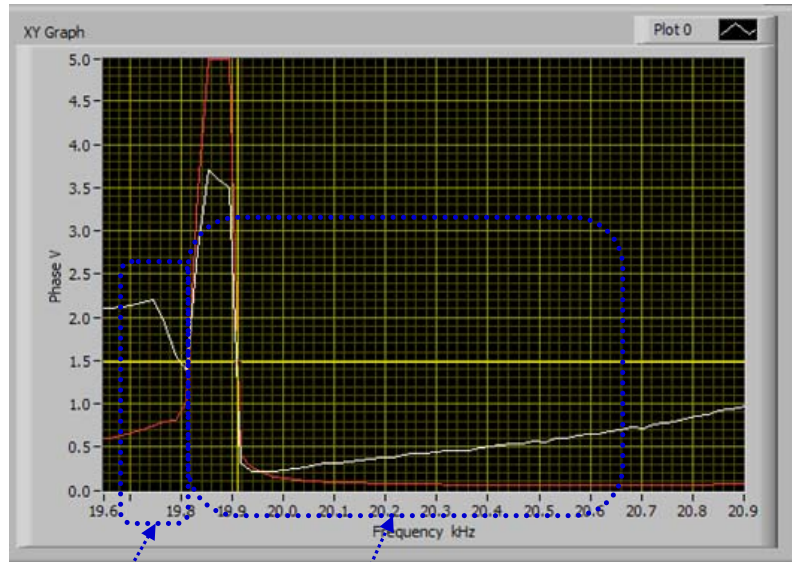

Fig. 9. **Heavy-duty frequency operating area** (operate only under loading)

Here is very risky, high stress operating area. Avoid operating here.

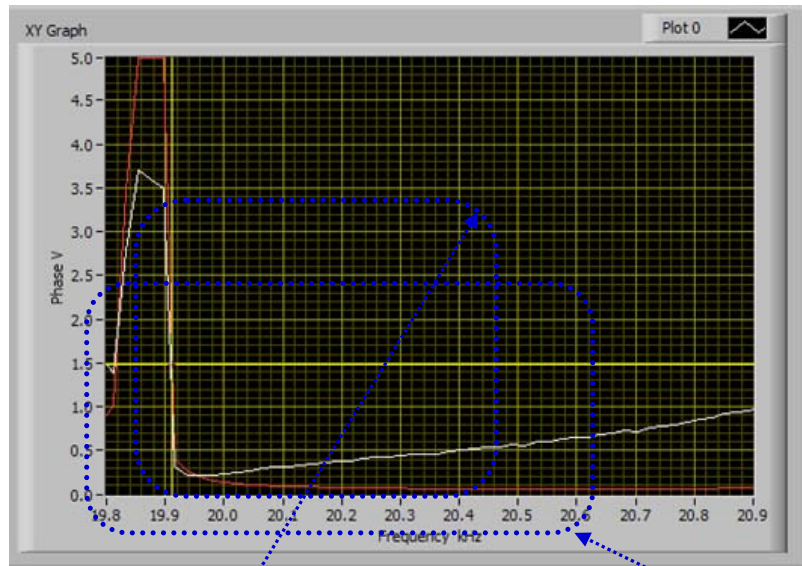

Fig. 10. **Wide moderate and high power frequency operating area** (for most of applications)

Select the frequency interval that covers only parallel resonance and higher frequencies, and does not cover series resonance. **This is the safest operating regime for low and moderate acoustic loads**, for welding, Sonochemistry, liquids atomizing and powders sieving applications, as well as for operating high amplitude in air. This operating regime has very high oscillating amplitudes and high oscillating velocity.

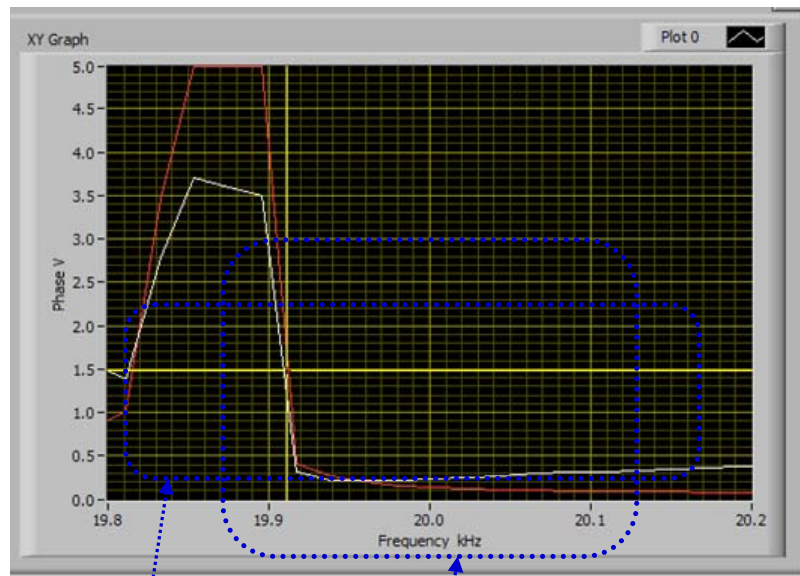

Fig. 11. **Well-selected frequency operating area for moderate and high power** (for most of applications)

Select the frequency interval that covers only parallel resonance and higher frequencies, and does not cover series resonance. **This is the safest operating regime for low and moderate acoustic loads**, for welding, Sonochemistry, liquids atomizing and powders sieving applications, as well as for operating high amplitude in air. This operating regime has very high oscillating amplitudes and high oscillating velocity.

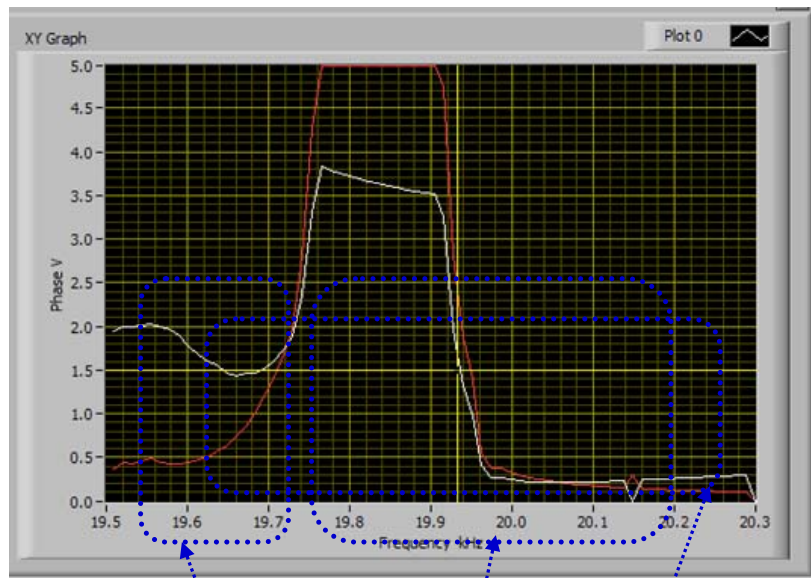

Fig. 12. Frequency **operating area for high power, heavy-duty** (for metals welding applications). Operate only under loading (**not in air**). Risky operating regime.

In all cases when series resonant frequency and certain frequency interval below is captured, this is presenting **very risky operating zone**. Test carefully and modify parameters until safe operating regime is found.

Moderate power, safe-operating frequency area (operating in air, for atomizing and powders sieving applications)

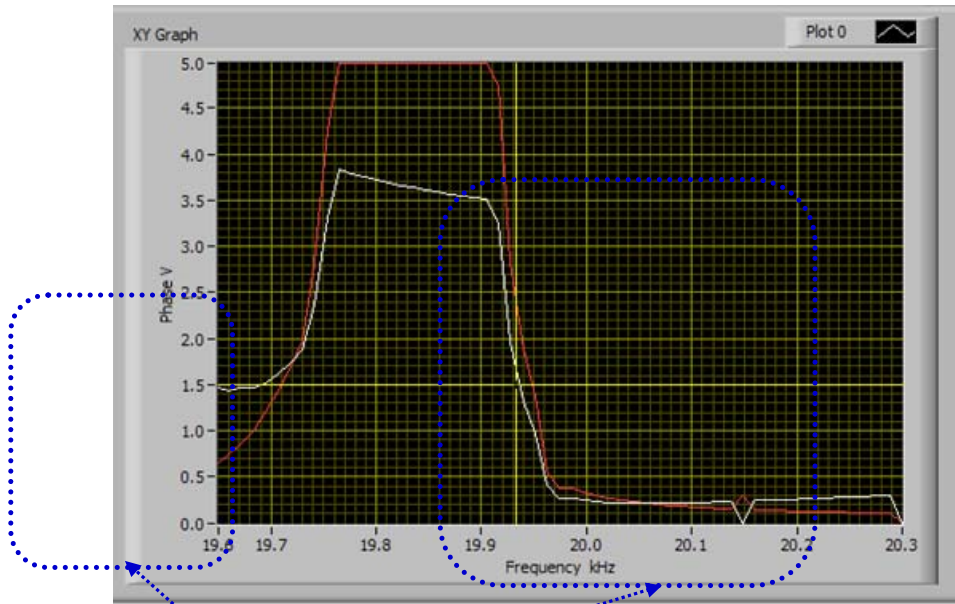

Fig. 13. **Well-selected frequency operating area** for moderate high power (for most of applications)

On this frequency-capture-range, **frequency area below series resonance is avoided.**

Select the frequency interval that covers only parallel resonance and higher frequencies, and does not cover series resonance. **This is the safest operating regime for low and moderate acoustic loads,** for welding, Sonochemistry, liquids atomizing and powders sieving applications, as well as for operating high amplitude in air. This operating regime has very high oscillating amplitudes and high oscillating velocity.

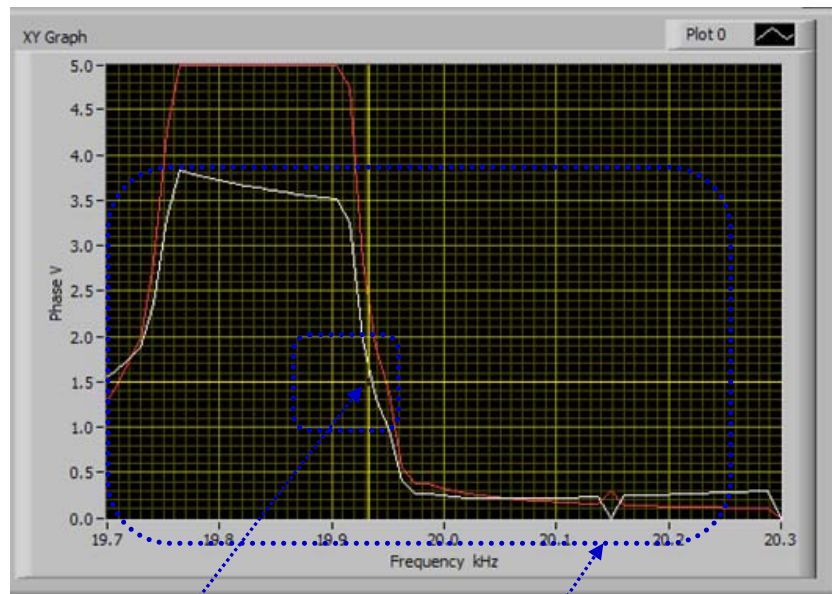

Fig. 14. **Well selected phase set point** (here 1.5 V). Should always be selected in a lower linear zone of phase curve with negative slope.

This is very well selected frequency area for most of moderate and high power applications.

Select the frequency interval that covers only parallel resonance and higher frequencies, and does not cover series resonance. **This is the safest operating regime for low and moderate acoustic loads**, for welding, Sonochemistry, liquids atomizing and powders sieving applications, as well as for operating high amplitude in air. This operating regime has very high oscillating amplitudes and high oscillating velocity.

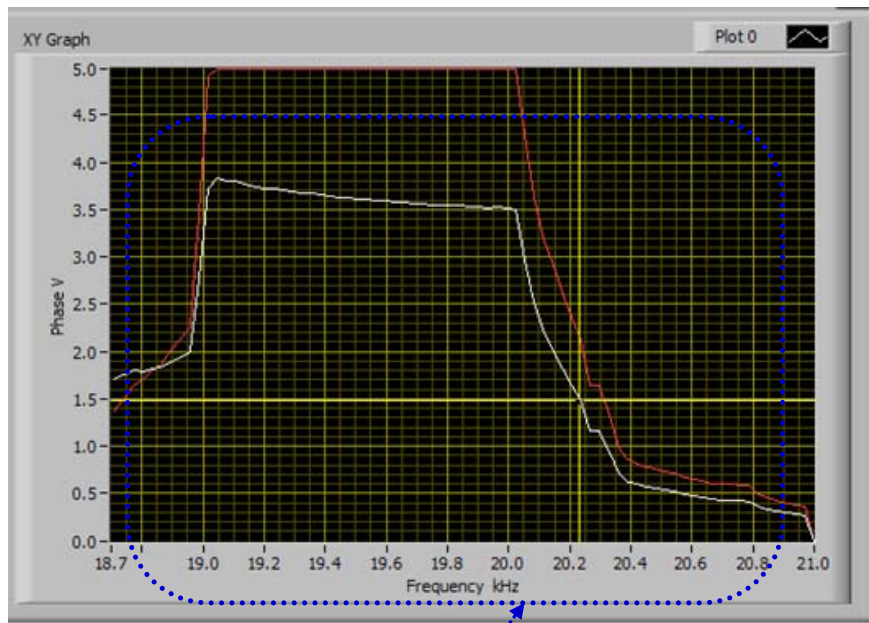

Fig. 15. Well selected, reduced frequency operating area for moderate and high power (for most of applications) and for very fast welding (start-up transient time between two welds is very short).

Select the frequency interval that covers only parallel resonance and higher frequencies, and does not cover series resonance. **This is the safest operating regime for low and moderate acoustic loads**, for welding, Sonochemistry, liquids atomizing and powders sieving applications, as well as for operating high amplitude in air. This operating regime has very high oscillating amplitudes and high oscillating velocity.

Very good settings strategy for reaching optimal operating conditions

1. If you have impedance analyzer, make impedance measurements and select initial scanning range that will capture both series and parallel resonant frequency and little bit wider (on both sides).
2. Measure and/or calculate the frequency interval between series and parallel resonant frequency $\Delta f = f_p - f_s = f_2 - f_1$
3. Set the **Span** value (on the first settings tab) to be between $\Delta f < \text{Span} < 6\Delta f$, (optimal Span could be between 2 and 4 Δf). Test later different Span values and select one that is producing optimal operating conditions.
4. Initially set the **Start frequency** to be in the low phase, low current zone (far from any other resonance), and to have the value $f_{\text{start}} \leq f_p + 3\Delta f = f_s + 4\Delta f$ (below maximal frequency).

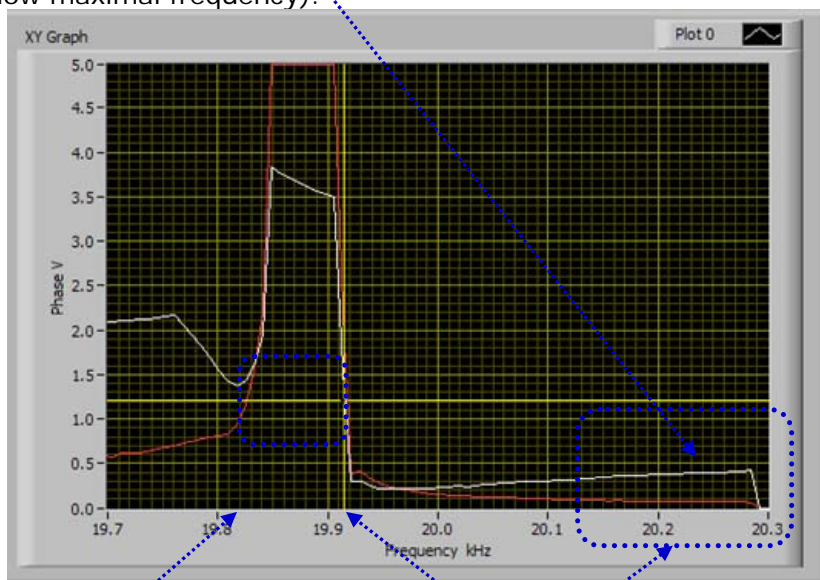

Fig. 2. Typical scanning curve (wide-scanning range).

Here is series resonant frequency f_s . Here is parallel resonant frequency f_p .

Select Start frequency somewhere here

5. Make all scanning, testing and tuning as already explained in this manual, while also respecting points 1, 2, 3 and 4 (see above on this page).
6. Test the generator and verify if amplitude and phase are being regulated correctly (and automatically). Try operating mostly around parallel resonance.
7. Readjust only start frequency going from higher to lower frequencies until reaching proper and stable, automatic regulation of **phase** and **amplitude**. Do not increase the Span. Optimal operating conditions in this case will found only by readjusting start frequency. All other setting parameters will stay unchanged as previously selected).

EXTREMELY IMPORTANT

The most important (unavoidable, ultimate objective) for resonance or frequency-phase tracking modes is to achieve stable, automatic, real time phase and amplitude regulation when transducer is loaded (and operating on a sufficiently high power, above the critical power threshold).

To recognize that we realized such operating regime we should compare:

- a) **Phase set point value** with the actual, real-time **regulated phase value** and the **numbers in both windows should be almost the same.**
- b) **Amplitude set point value** with the actual, real-time **regulated amplitude value** and the **numbers in both windows should be almost the same.**

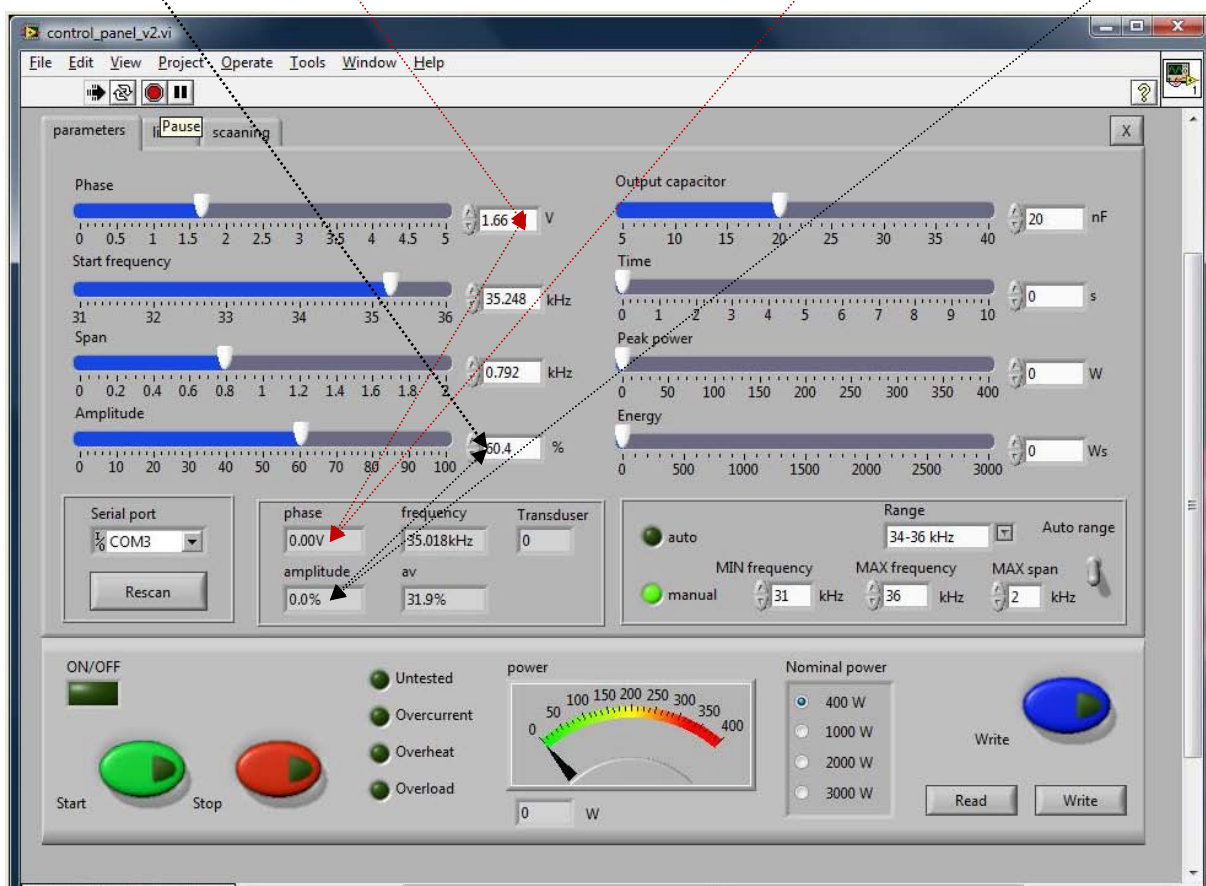

To achieve described automatic tracking the Effective Phase set point, start frequency and frequency Span can be slightly readjusted in real time, during ultrasonic generator operating high power, until we reach desired operating amplitude regulation, while still keeping automatic effective phase regulation. These are very important and very useful options.

Amplitude: This is very particular amplitude regulator, which is starting to regulate amplitude from certain (minimal) threshold point (which is specific for every ultrasonic load). Below that amplitude threshold point there is no automatic amplitude regulation (amplitude is too small to be regulated). Starting from the amplitude threshold AMMM generator is making automatic amplitude regulation (percentage-wise), which should be almost equal to the set point level of **amplitude given on the first TAB settings**. Upper amplitude level that can be reached by automatic regulation is also limited. Example: For certain transducer, we will be able to have smooth, automatic amplitude regulation only between 20% and 70% of the full scale (and **we should never expect that automatic amplitude regulation will operate from 0 to 100%**).

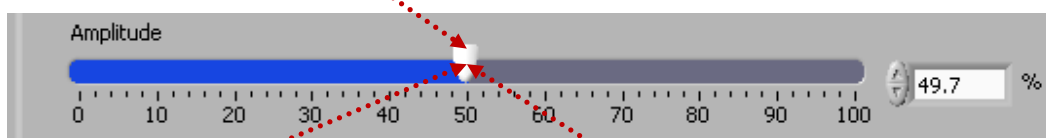

If mechanical (ultrasonic) load starts consuming power that numerically corresponds to the **percentage of the amplitude set point**, generator will start regulating power instead of regulating amplitude, but using the same numerical value **of the amplitude**. Example: If the set point of amplitude is 50%, generator will regulate amplitude on 50% in the power range from 0% to 50%. If consuming power will increase (over 50%), generator will start regulating only the power taking 50% as the nominal generator power or set point for power (and amplitude will automatically decrease, giving priority to the power regulation). If the consumed power will drop below 50%, amplitude regulation will automatically become dominant regulating process, and amplitude will be regulated on 50%.

Power regulator (%): Is the actuator value of the automatic (closed loop regulator) **for amplitude and/or power**. This is real time indicator. Ideal situation is for power regulator is to be close to the set point of amplitude (and/or power).

OPTIMAL GENERATOR SETTINGS

1. Whatever we do with different generator settings, the answer if this is beneficial for ultrasonic operating regime is the **output power level** that **should be maximized with every particular setting** (watch analog power level meter).
2. The second important criteria is that **ultrasonic load** would **operate very smoothly**, without producing sharp, strange, cracking, whistling, clipping and/or low frequency noise or similar effects.
3. The most important criterion to be able to say that ultrasonic system is operating properly and safely (and that will last very long time) is that **nothing is significantly and rapidly heating**. For instance, ultrasonic transducer, other metal parts, executive resonating tools and load should not dissipate too much heat energy and no one joint should heat. Also ultrasonic generator (box) should not heat. Temperature during operation for all mechanical parts should always be close to room temperature and below 50°C.
4. After certain settings are made (when generator is not operating, or during generator operation, in real time, including additional settings and adjustments made later), every time is necessary to save such settings (regardless if generator is operating or not), if we would like that next time (after **switching OFF the generator and repeating switch ON**) generator would start using last settings. When make SAVE = **Write** (by pressing blue button on the bottom right side of the software user-interface panel) the last settings are stored in the generator for currently operating transducer. If the save button (blue button) is not pressed, nothing is saved in the generator, even if adjustments are made during tests (when generator operates). The same procedure should be repeated for every new (different) transducer.

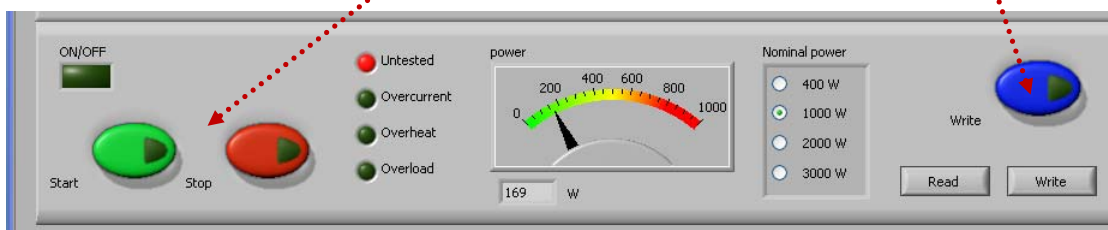

After every power-up it is absolutely necessary to test and find new operating frequency of transducer/s. Why? Let's imagine that generator and transducer are operating for long time under some conditions which are related to: ambience temperature, temperature of piezoceramics, temperature of sonotrode... Such conditions are defining operating frequency of ultrasonic system, which could vary/deviate until 1 kHz compared

to initially tested frequency (when transducer was on a standard room, temperature). If the generator shuts-down (for some reason) and after certain time again powers-up (when temperature of critical components will naturally change), the applied automatics (PLC) which is controlling ultrasonic generator should test again all transducers (all older program parameters are still in the memory of the generator, but new situation related to temperature-dependent acoustic properties is no more the same).

- After all initial settings are made (using a PC and supplied Lab View software), Ultrasonic Generator can be activated, and it will start driving ultrasonic converter by pressing green **Start** button (which is on the software front panel; -lower left corner on all three TABs). Do not start the generator until all initial settings are verified and sett to safe (low power and low risk) positions after the **safe-operating ultrasonic load scanning**.

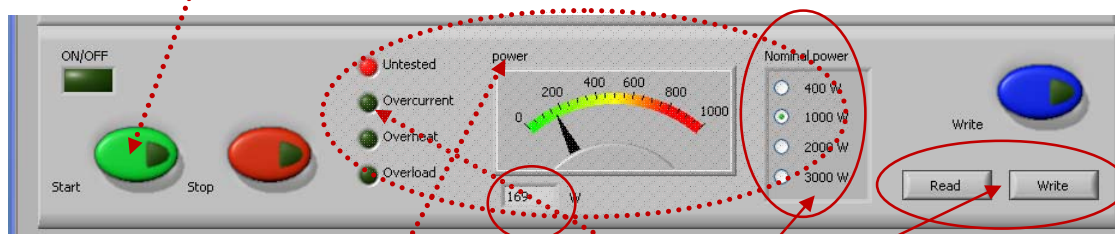

- Now ultrasonic power output can be switched **ON (Start)**. In case if ultrasonic transducer (meaning complete ultrasonic load) is overloading WELDING generator, generator will stop operating and show **ERROR message (overcurrent, overheat, overload)**. Red color LED on the generator box (front panel) will light, and one of visual indications (either **Overcurrent** or **Overheat, Overload**) on the LabVIEW user-interface (lower left side) will be activated. Reduce the amplitude, readjust operating frequency, find new settings (slightly different compared to what was before), and repeat the process until successfully restarting the generator.
- Read – Write options:** After all settings are properly and optimally made, we can save the file with such settings using **Write** button (like saving any PC file). We are giving to such files any name/s we like with “.tune” ending. Later, we can simply invite/**Read** one of such files (for a specific load) and WELDING generator will start operating as previously memorized (taking settings data from a specific .tune file).
- Power, Power selector:** Proper power level should be selected (related to applied generator)
- Power:** Visual (analog) indication of the power level.

Power indicator: (=) actually regulated power which corresponds to the PWM duty cycle
 (=) Numerical duplicate of the analog power indicator. Non-editable fields: only indicators.

10. Before exploring any of OPERATING MODES OF WELDING ULTRASONIC GENERATORS, select proper operating frequency **Range**, which corresponds to a known operating frequency range of ultrasonic transducer (or load), or enter other numerical values **manually** in the following format: 19-21 kHz (just an example).

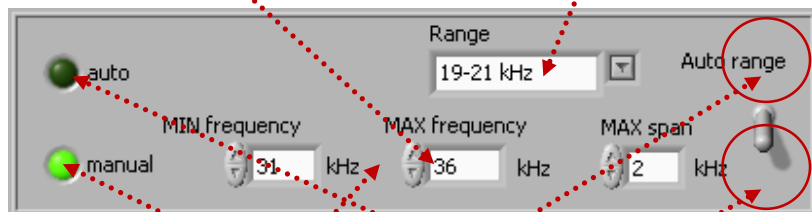

If the **Range Switch is in upper position (=) Auto range**, many of predefined frequency ranges will automatically appear (**upper green LED will light**). If we need another frequency range, we can simply type new numbers.

If the **Range Switch is in lower position (=) Manual range**, user can enter arbitrarily chosen frequency and span values (**lower green LED will light**).

Every ultrasonic transducer and/or ultrasonic load has its acceptable/tolerable and optimal operating frequency range/s (It is usually designed and optimized to operate on certain resonant frequency). Do not select frequency ranges that are not acceptable for ultrasonic transducer and ultrasonic load (something will be damaged). In addition, frequency ranges that are too much different, compared to the producer-specified operating frequency range of applied ultrasonic transducer should not be used. In many cases, operating ranges should be selected **manually**, because standard default values are not covering desired operating frequency zone.

11. **Effective Phase set point, start frequency and frequency Span can be later slightly changed in real time, during ultrasonic generator operating high power, until we reach desired operating amplitude regulation, while still keeping automatic phase regulation. These are very important and very useful options.**
12. Do not forget to activate cooling on ultrasonic converter (if operating in heavy duty conditions).
13. Monitor operating temperature on all oscillating parts (converter, booster, sonotrode) and if temperature is non-uniformly distributed and significantly increasing in certain zones, stop the generator and find reasons causing temperature rising (apply refastening, new scanning...).

Literature: [Piezoelectric Transducers Modeling and Characterization \(e-book\)](#)

SETTING & SCANNING example for DUKANE 20 kHz welding converter (2 kW)

SHORT REMINDER FOR BEGGINERS

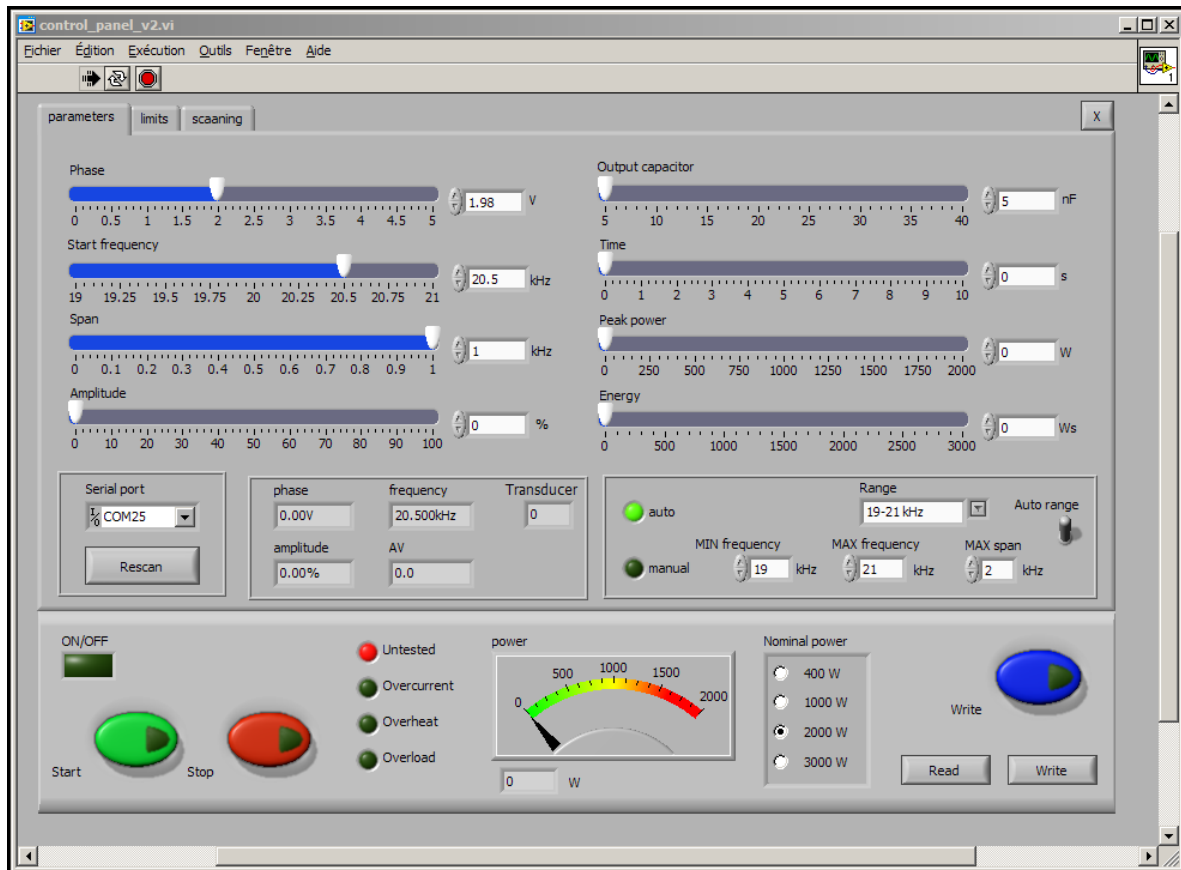

- Install all necessary LabView software (read our manual).
- Activate MPIwelding.exe
- Select proper Serial port (Rescan). Verify that connection to your PC is activated.
- Set output capacitor to minimum (5nF) before scanning
- Set Time, Peak power, Energy to "0"
- Set Nominal power to what correspond to hardware (here 2000W)
- Select frequency Range, or MIN and MAX frequency & MAX span.
- If Auto frequency range is used, span is automatically selected to be 1 kHz
- Always stop the generator before changing "Output capacitor"

-Do not forget to activate blue button "Write" after every modification

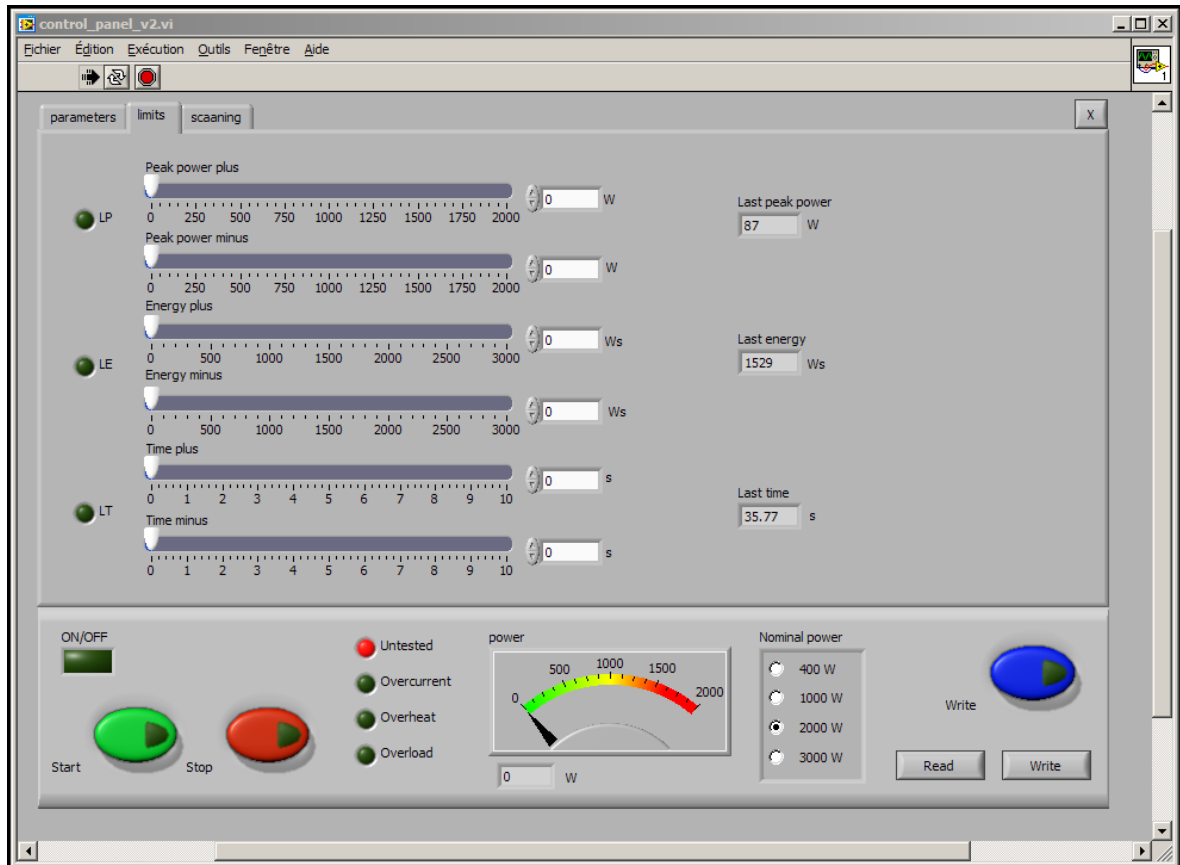

-Set all values to « 0 » minimum before scanning

-Do not forget to activate blue button "Write" after every modification

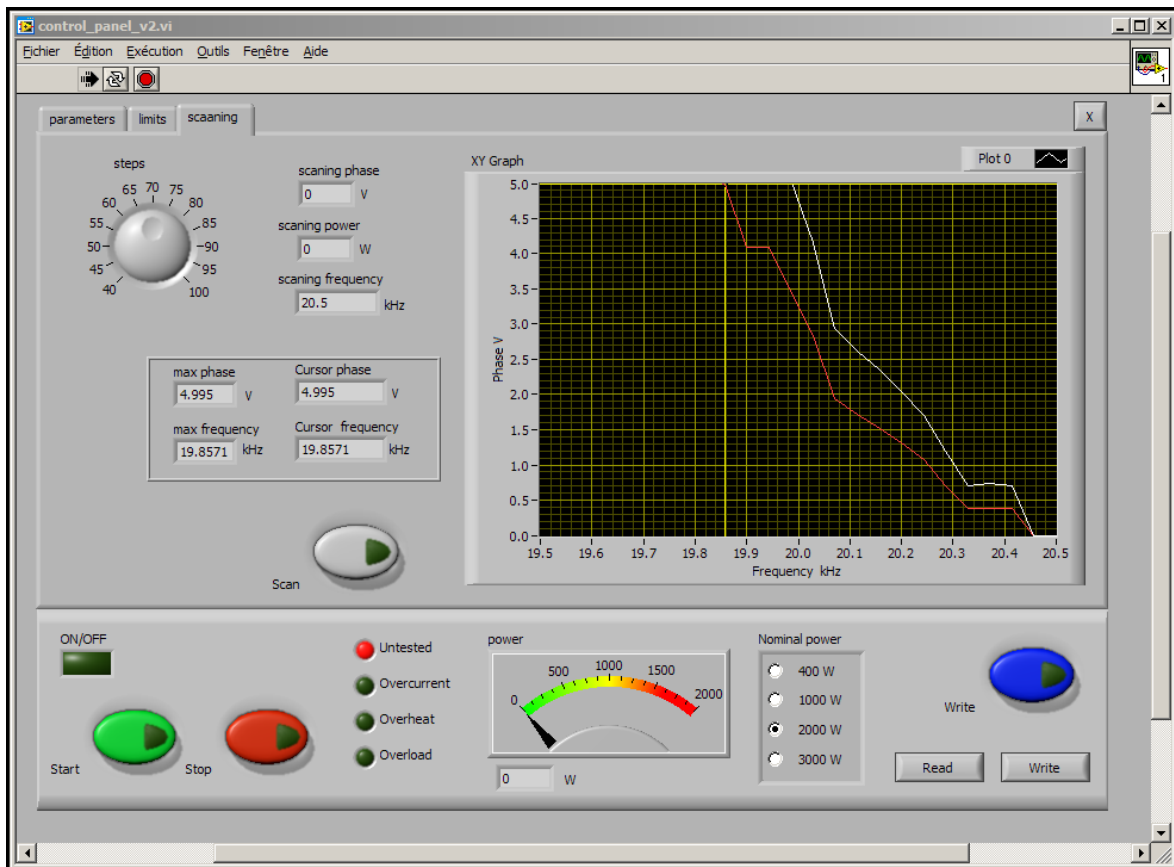

-Scanning diagram (after scanning). In this case we do not see series resonance, but after we add booster/sonotrode... we will be able to see series resonance.

-Select Phase set point in the middle linearity area of white curve (here 2 V looks OK), and go to the first TAB (parameters) and set selected Phase.

-Do not forget to activate blue button "Write" after every modification

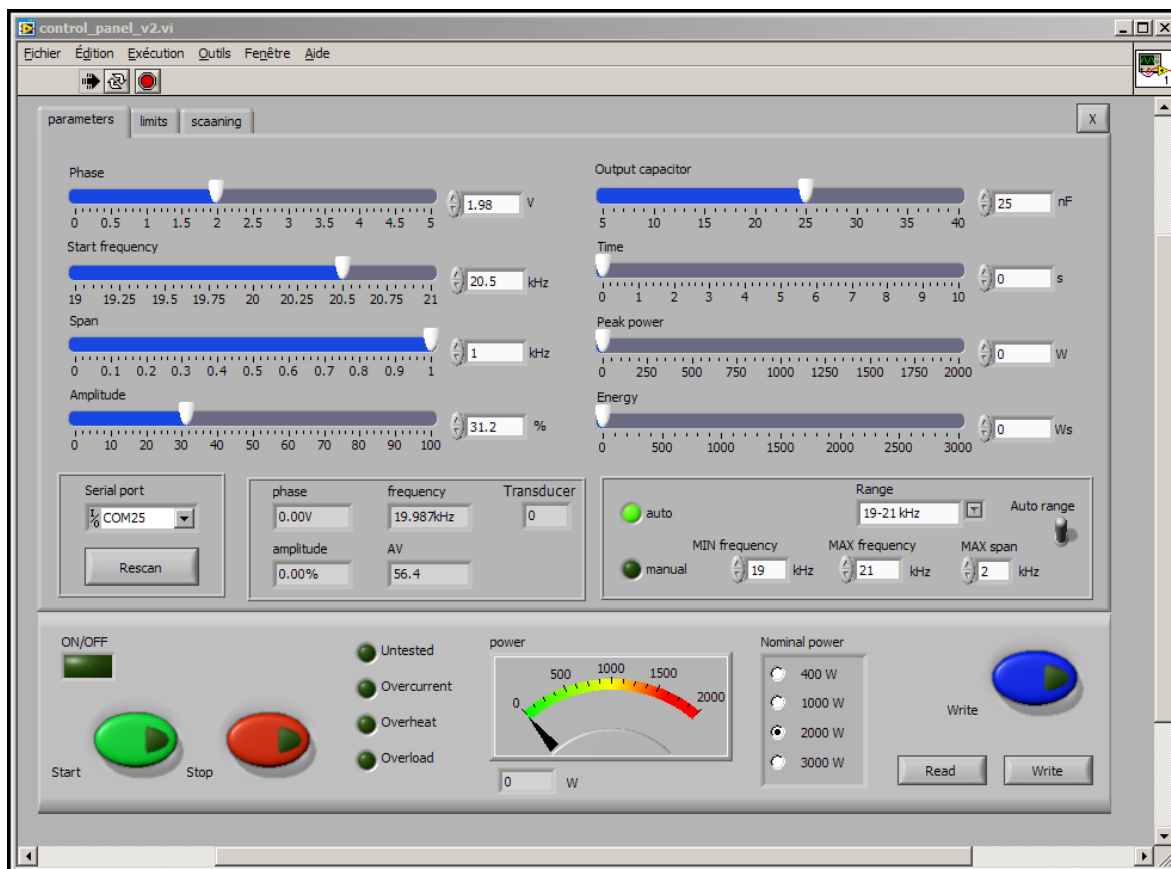

-Operating situation after scanning: First TAB (parameters).

-Increase output capacitor gradually, as long automatic amplitude and phase regulation is operating correctly.

-For first Start select Amplitude to 20%, later increase... First Start will repeat and verify Scanning and if everything is OK, generator will stop without generating error message. Second Start (green button) will activate converter.

-In case if/when adding/changing booster/sonotrode/converter, repeat scanning

-Later follow manual. Set operating mode (Time, Peak power, Energy...).

-Always stop the generator before changing "Output capacitor"

-Do not forget to activate blue button "Write" after every modification

FRONT PANEL, MANUAL SETTINGS & REGULATIONS

After all optimal settings are found and memorized using LabVIEW software ([MPIwelding.exe](#)) we can disconnect RS485-USB controls (stop using PC controls) and continue using only manual settings and controls from the generator front panel (LCD + Rotary encoder).



Changing the Menu options (on LCD) can be realized by pressing the Menu knob. Changing actual, numerical values (on LCD) can be realized by rotating the Menu knob (in the middle). It is always better, safer and more comfortable to make such modifications and setting using LabVIEW user-interface software.

WELDING generators can also be controlled using a PLC or analog signals.

In some of customized WELDING generators we could find either 15-pin or 25-pin Canon (Sub-D) connectors for RS485 interface (usually on the back plate). All pins from 1 to 15 on 15-pin connector are identical to pins from 1 to 15 on 25-pin connector.

On the front panel of WELDING generators there is another RJ45 connector which is also used for RS485 communications between generator and PC (see below).

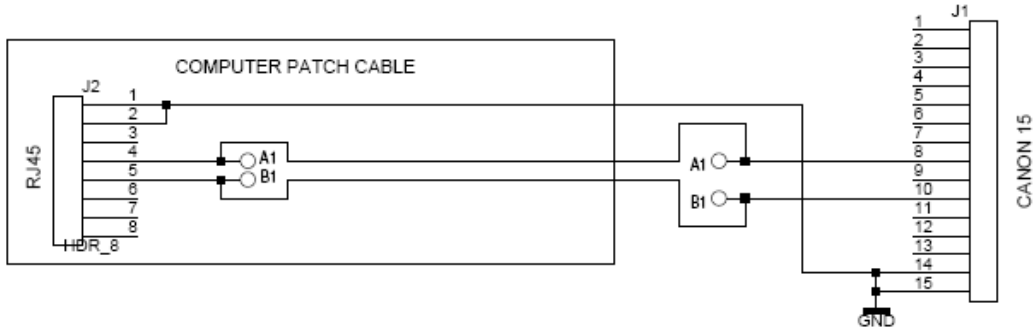

CONNECTORS OF RS485 - USB ADAPTER

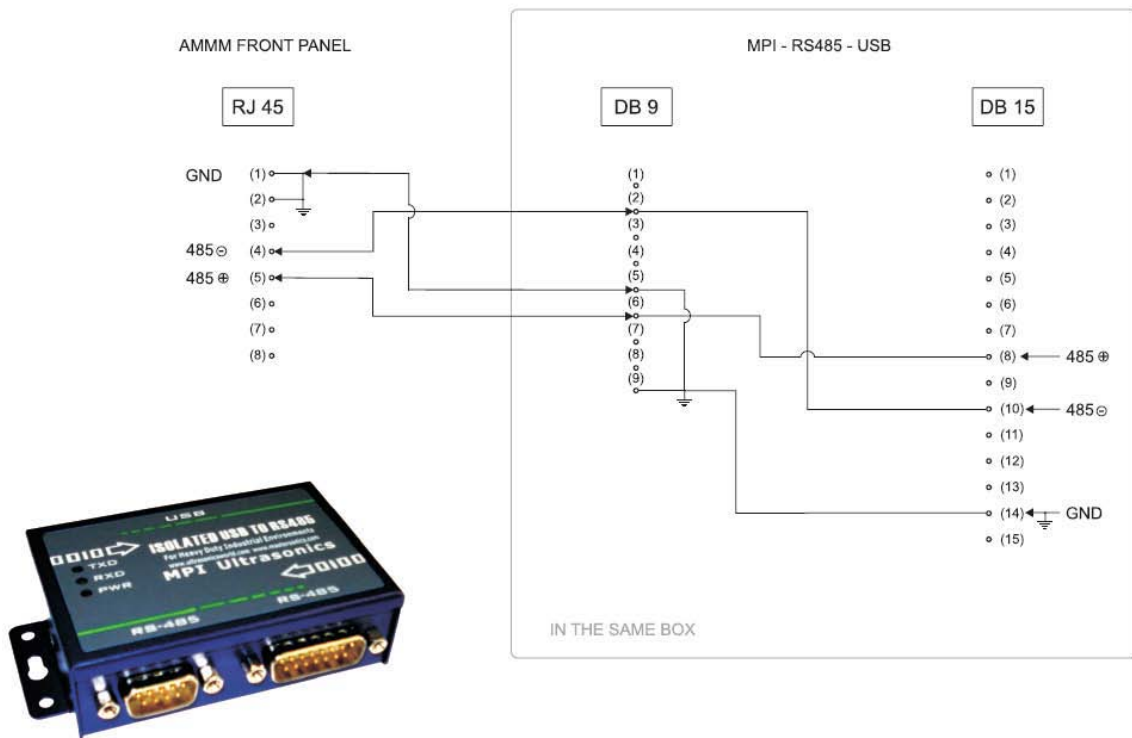

ADDRESSING & NETWORKING

We can also apply (only as an option; -non standard version) additional 25 pin connector for (external) manual, switchable addressing of different converters and sonotrodes (with in advance memorized settings), as for example:

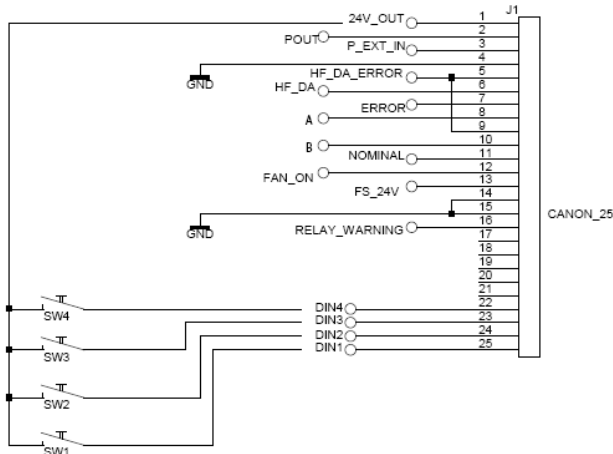

	SW1	SW2	SW3	SW4	
	OFF	OFF	OFF	OFF	TRANSDUCER 0
	ON	OFF	OFF	OFF	TRANSDUCER 1
	OFF	ON	OFF	OFF	TRANSDUCER 2
	ON	ON	OFF	OFF	TRANSDUCER 3
	OFF	OFF	ON	OFF	TRANSDUCER 4
	ON	OFF	ON	OFF	TRANSDUCER 5
	OFF	ON	ON	OFF	TRANSDUCER 6
	ON	ON	ON	OFF	TRANSDUCER 7
	OFF	OFF	OFF	ON	TRANSDUCER 8
	ON	OFF	OFF	ON	TRANSDUCER 9

_Generators have network function/s but all of them until now are on the same address - 06. -02 address is reserved for LabView software. -All other addresses are free for use. To set the new address of AMMM generator will be possible (allowed):

-from LCD panel

-And/or from LabView software (ammm.exe).

-The address is on the LCD - like parameter. -Every new generator is working on address 6 and could be changed (from LCD) to every upper address from 7 to 30.



-In case of network application/s of many generators, all units should be connected to the same ground.

-Otherwise galvanically (optically) isolated rs485 converters are needed... (also supplied by us).

ONLY FOR EXPERTS AND TRAINED BY MPI

Our ultrasonic power supplies, beside software settings, can also be internally adjusted to operate number of different ultrasonic transducers. For instance, if ultrasonic transducer has certain low or high, maximal, safe operating voltage (on piezoceramics), output generator voltage should be, and can be changed internally by selecting proper jumpers. In addition, internal compensating inductance could have different values, selectable by jumpers, in cases when effective, static capacitance of certain transducer is too low or too high (not covered by factory default settings).

We are not suggesting to our clients to play with such options, except if they are trained by MPI, and already well experienced in Ultrasonics R&D. They can get such training from MPI, and they anyway need to have specific test and measurement equipment (such as: an Oscilloscope with differential, floating inputs with amplitude gain from 1 to 1000 in order to measure low and very high RMS voltage, Impedance analyzer, R-L-C meter etc...).

See such jumpers' adjustable situations on the next three pages.

Internal output voltage and inductive compensation jumpers for 400 W generators

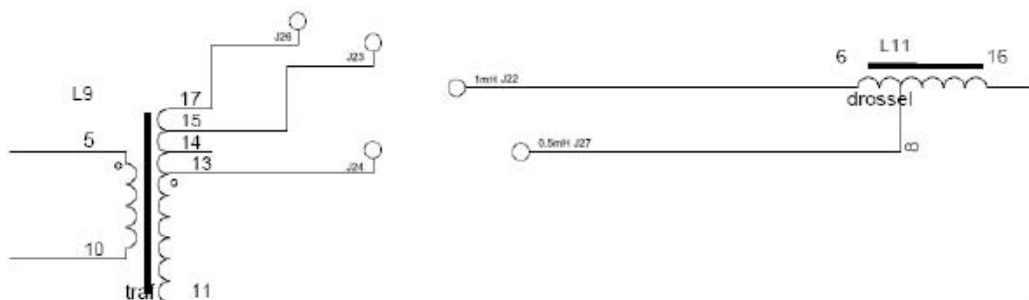
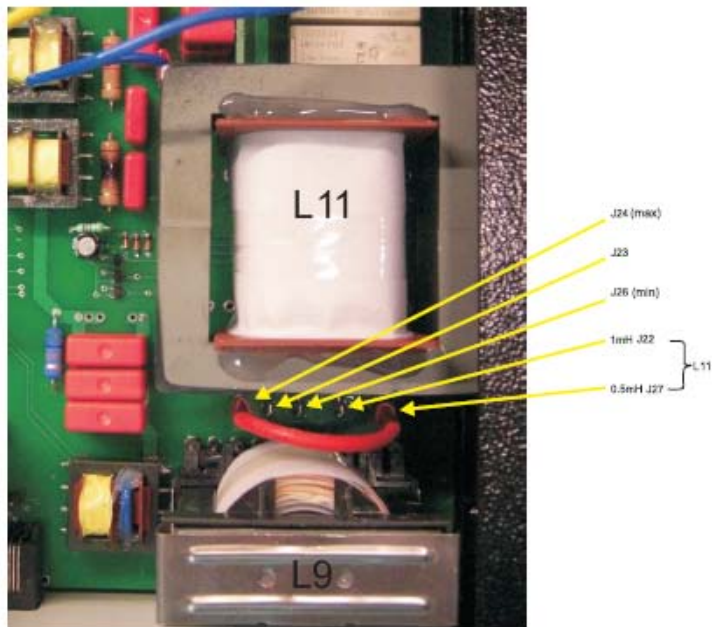
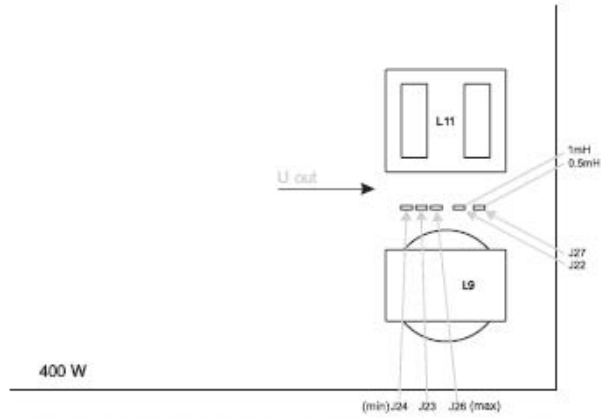

Internal output voltage and inductive compensation jumpers for 1kW generators

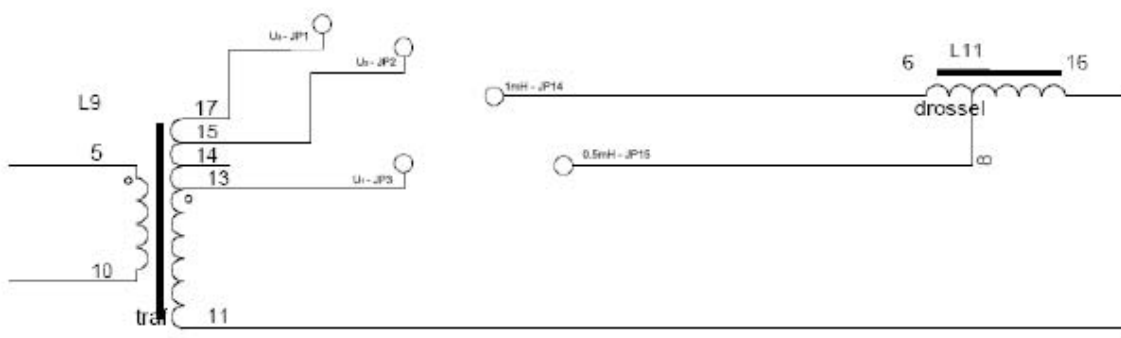
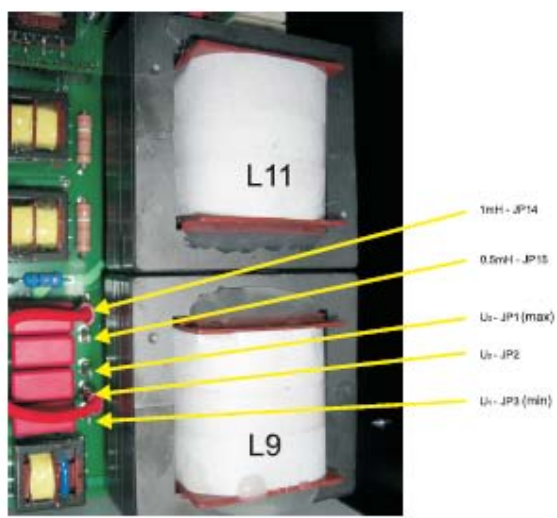
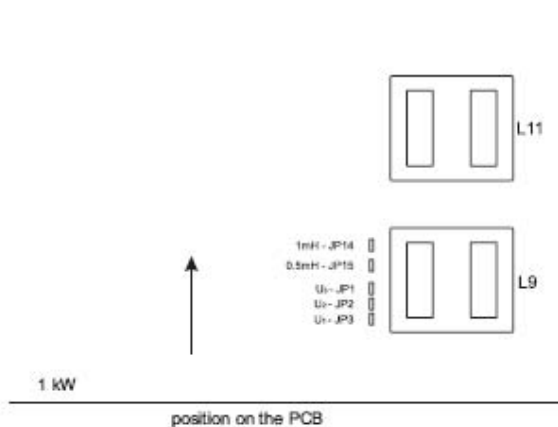

Internal output voltage and inductive compensation jumpers for 2 & 3 kW generators

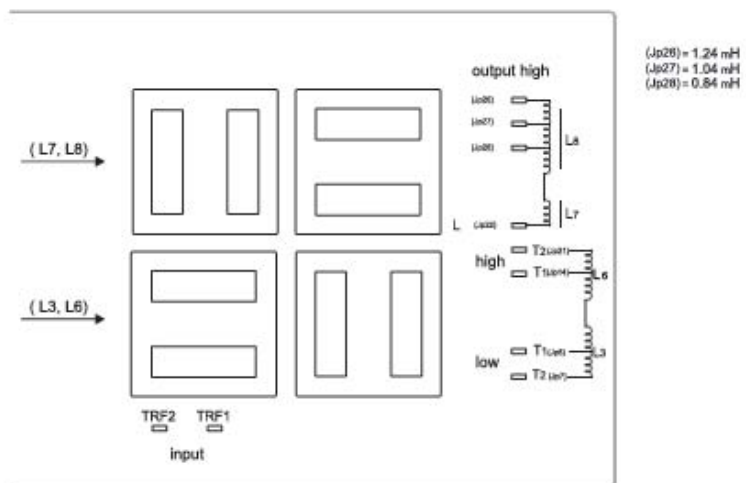

2 & 3 kW

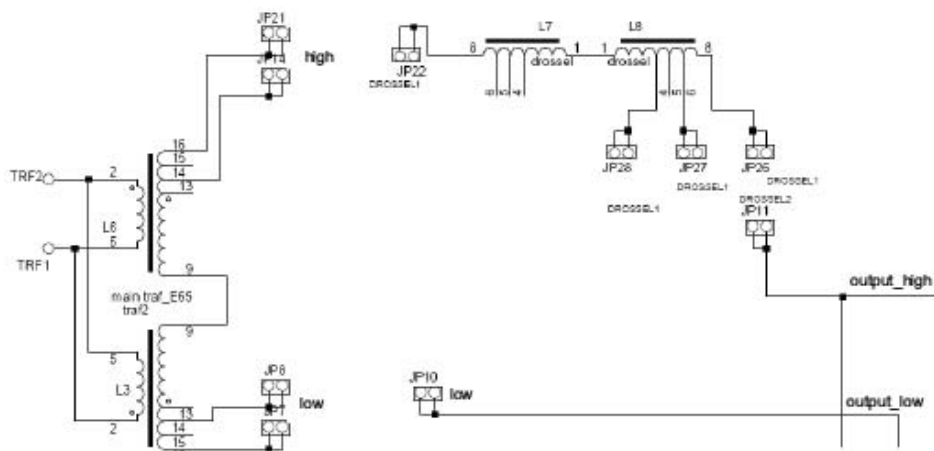
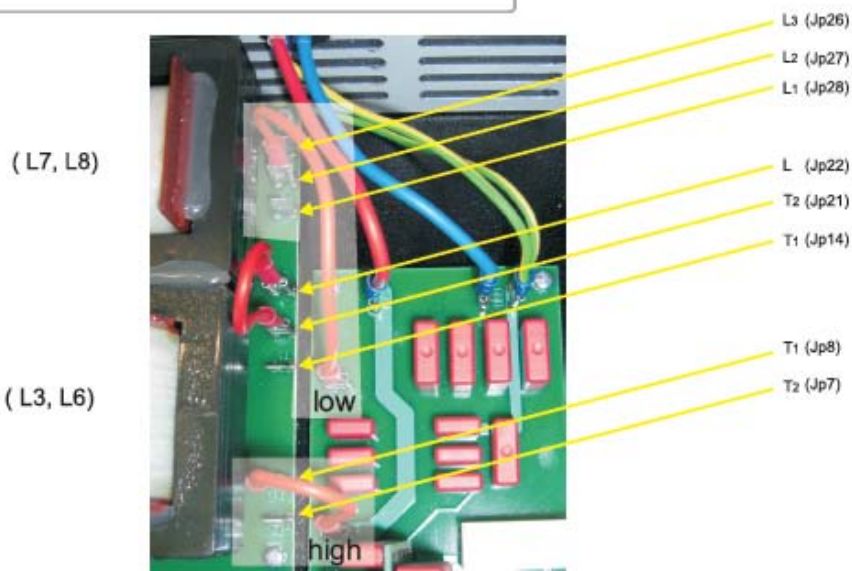

SAFETY INSTRUCTIONS

Before starting up your device, please read through the following instructions carefully, both for your own safety and for the safety of the device.

Keep this manual where it can be readily accessed by all systems users.

Installation is to be carried out by qualified technical personnel only!

The ultrasonic generator is to be operated by properly trained personnel only!

Due to the way it operates, **additional** safety measures must be taken if the device is to be used in areas posing an explosion risk.

The electromagnetic compatibility corresponds to the standards and regulations listed in the specifications.

All necessary settings were either made in the factory or are described in this handbook.

However, should problems occur on start-up, please do not make any prohibited adjustments to the device, as this would endanger your warranty rights. If in doubt, please contact our technical service staff.

Please contact our technical service if you have any doubts or questions.

Work inside the device may only be carried out to the extent described and, as with the electrical connection, should only be performed by skilled personnel. When performing such work, the ultrasonic generator must be completely disconnected from the mains (unplug the mains connection).

Inputs or outputs that are used for controlling or monitoring purposes should be twisted and shielded.

The device must not be in close proximity to electrically charged components or cables.

The shielding should be connected to the generator's earth on one side of the generator.

Attention: All connections for the signal or control lines are in galvanic connection with the generator.

Always observe any warnings or instructions given on the device itself.

The device must always be disconnected from the mains before cleaning or when installing/uninstalling an option.

Do not use liquid cleaners or sprays. Only use a damp cloth.

The platform for the device must be sufficiently stable, as the device being jolted or falling could cause severe damage.

Ensure that the power supply specifications given on the device are met.

Only those transducers that have the correct frequency, power output and dimensions may be used with this generator.

HF cables from the generator to the transducer as well as mains cables to the generator may not be rolled up if they are too long. Instead, they must be shortened to the required length due to the risk of overheating.

With the exception of the permitted tasks listed in the handbook, you should never attempt to repair or modify the device yourself.

In the following cases you should disconnect the device from the mains and contact a qualified service engineer:

- **If the mains cable or plug is damaged**
- **If liquid has penetrated into the device**
- **If the device has fallen over or the housing is damaged**
- **If the device displays noticeably different behavior than standard operation**

ATTENTION: Repairs and modifications may only be carried out by competent, skilled personnel.

ERROR MESSAGES AND TROUBLESHOOTING

The following error messages may appear in the display:

“OC” OVERCURRENT

The electronic over-current fuse has detected an error

Possible causes:

- Transducer is defective
- Power supply or plug is defective

Remedy:

- Unscrew the transducer connection on the housing
- Switch on the generator without the transducer connected

a) Error message still displayed:

Generator is defective

b) Error message no longer displayed:

Check the transducer and power supply

“OH” OVERHEATING

The electronic overheating fuse has detected an error

Possible causes:

- Not enough space around the generator.
- Working surroundings are too hot

MAINTENANCE

The ultrasonic generator does not need special maintenance.

Dust and dirt should be removed regularly using a damp cloth.

ATTENTION:

- **Do not use aggressive cleaning solvents!**
- **Not suitable for ultrasonic cleaning!**

WARRANTY

The length and coverage of the warranty can be found in the terms of delivery as part of the general terms and conditions (valid at the time of purchase) or in the sales contract / order confirmation, should any special agreements have been made.

The following cases are not covered by warranty:

- Damage caused by inappropriate operation
- The device not being used for its intended purpose
- Inappropriate alterations or modifications made without prior authorization from the manufacturer
- Damage caused by extreme circumstances, such as knocks, falling over, moisture and dirt
- Insufficiently qualified operating staff
- Non-compliance with current safety and accident-prevention regulations
- Damage resulting from modifications made to the operating instructions

SERVICE HOTLINE

Should you still have questions after reading through the operating instructions thoroughly, please feel free to call our service hotline.

Please have the following information to hand to help us answer your questions quickly.

Device type, serial number (the serial number is on the backside of the generator)

SPARE PARTS

We can only deliver spare parts and accessories if you order them specifically.

Literature: [Piezoelectric Transducers Modeling and Characterization \(e-book\)](#)